

AALBORG PRIVATBANER.

Fortegnelse

over

Driftsmateriellet

1911

AALBORG

Wilh. Burmesters Bogtrykkeri

fotografisk genoptryk juni 1978.

JMJKs Forlag

eget tryk.

A 73

Dette hefte indeholder skitser af det rullende materiel fra Aalborg Privatbaner i perioden 1911 - 1928. Rettelser og om-
litreringer er dog ikke konsekvent gennem-
ført, således at der kan forekomme uover-
ensstemmelser.

Et værdifuldt supplement til dette hefte er: Fortegnelse over driftsmateriellet 1923, som ligeledes er genoptrykt af JMJKs forlag, pris 20,-. Heri finder man i skematisk form oplysninger om byggested, -år, ombygninger m.m.

Aalborg Privatbaners skæbne er beskrevet i en artikelserie i Signalposten, årgang 1969 nr 6 og 1970 nr 1 og 2. Desuden findes der enkelte fotos af rullende materiel i Signalpostens fotohefter 1 og 2.

Nedfotograferede originaltegninger findes for en del materiels vedkommende i JMJKs tegningsarkiv; katalog tilsendes efter henvendelse til nedenstående adresse.

Dette hefte kan købes ved indsendelse af 20,- på giro nr 1 30 85 72, JMJKs forlag, Nørre Alle 79, 8000 Aarhus C.

Aarhus, 1-6-1978

Niels J. Hansen

A. 1-2.

1.

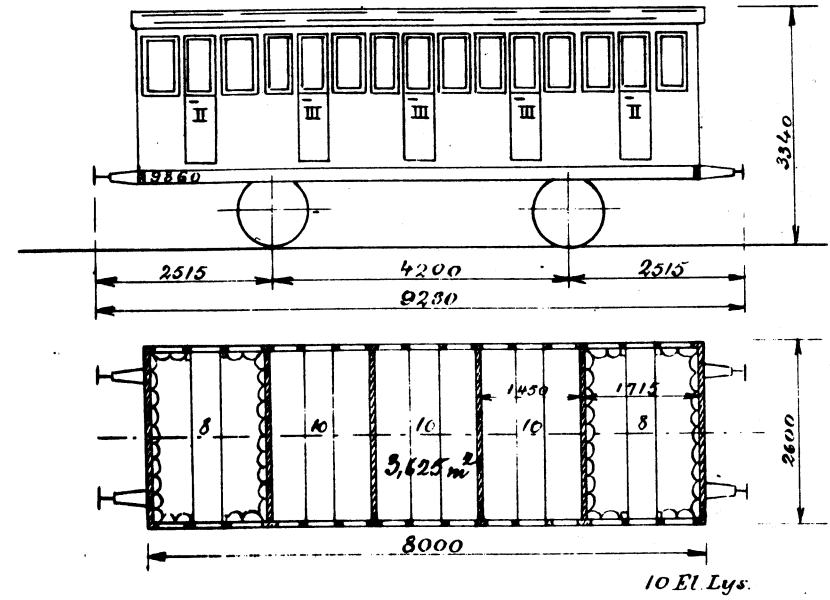

A. 3-6.

2.

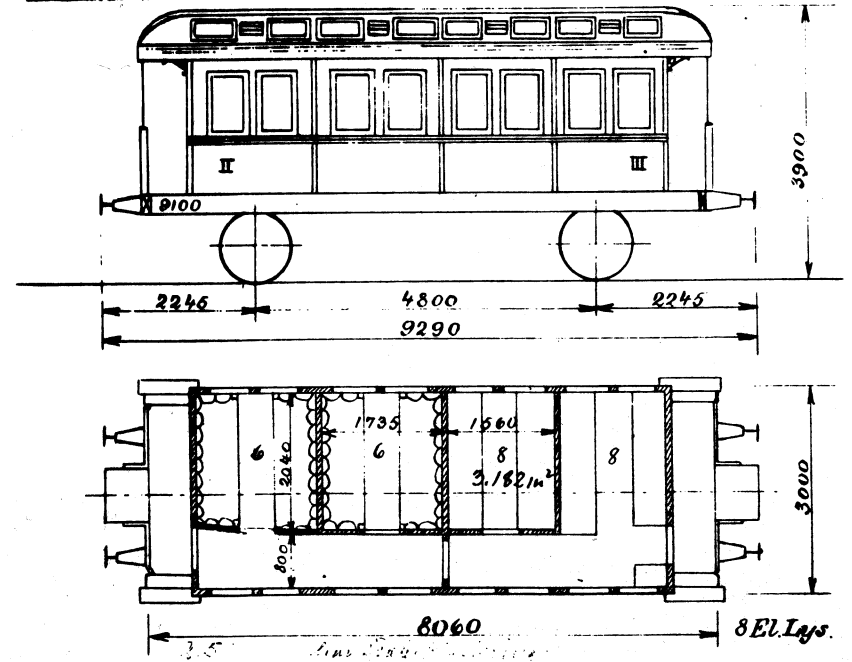

A. 7-8.

3.

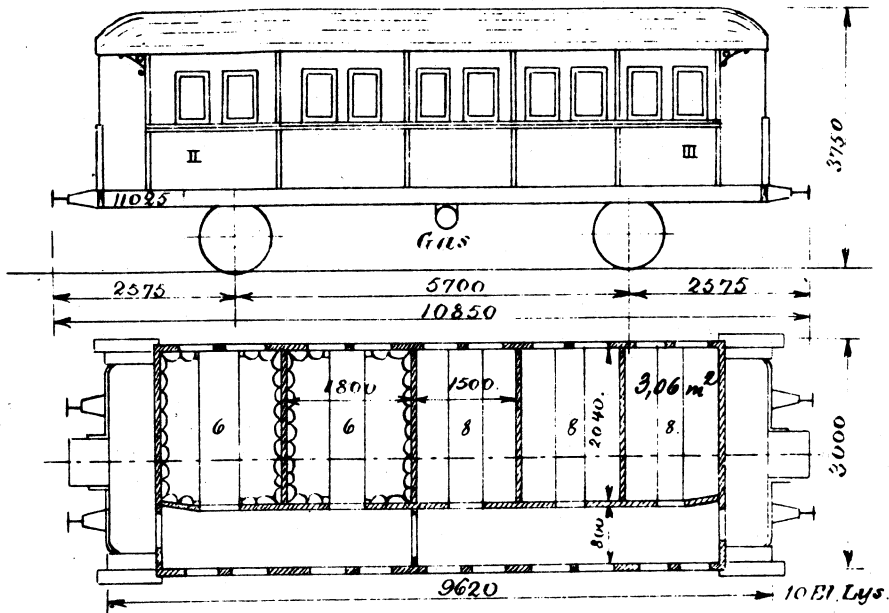

A. 21. ex VLJB5FL AHG 1902

4.

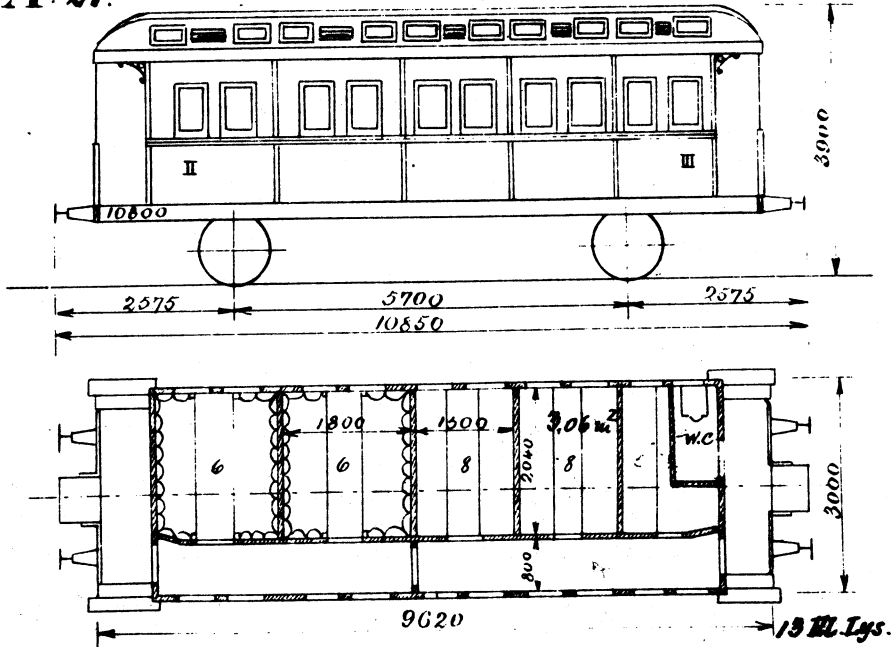

B. 31-32. (C. 198-15 FL)

5.

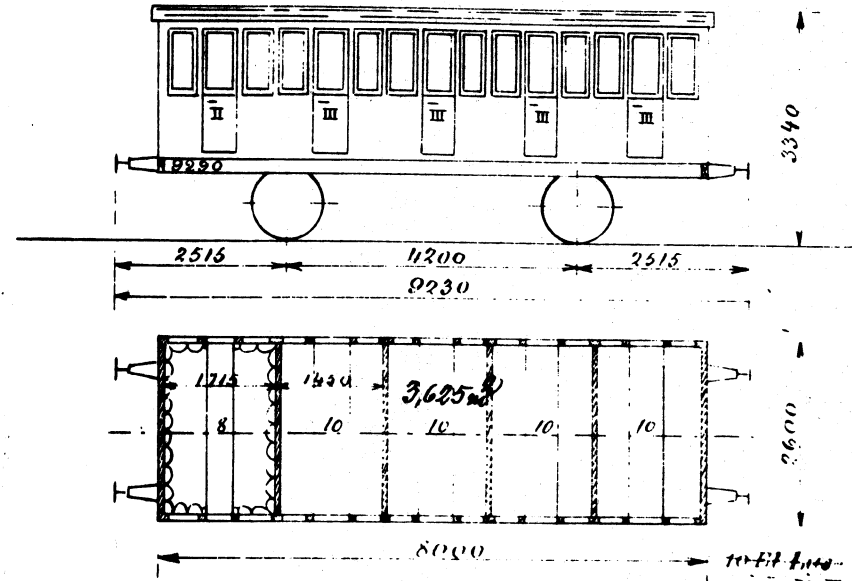

B. 33-34.

6.

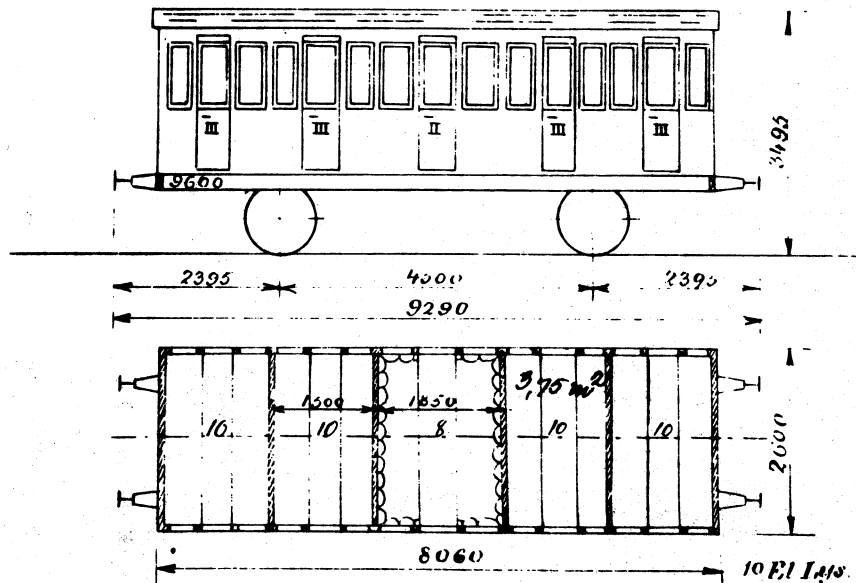

B. 35-36.

7.

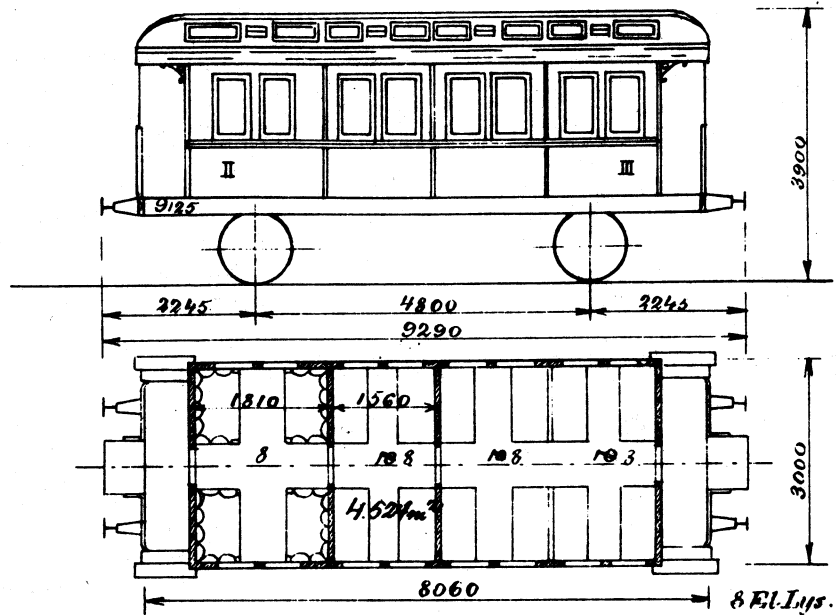

B. 51-52. (B-51 ombygget til C. 191-192 i 1906.)

8.

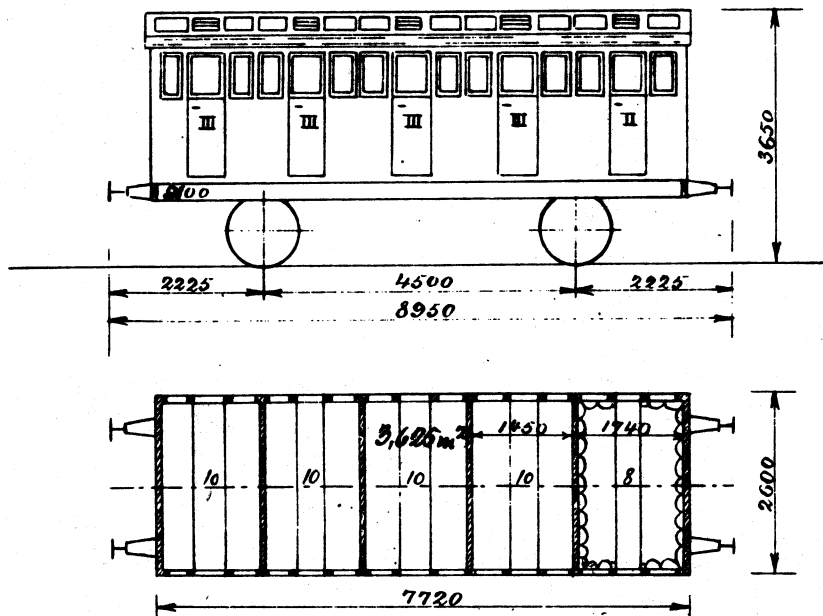

B.v. 61-62.

9.

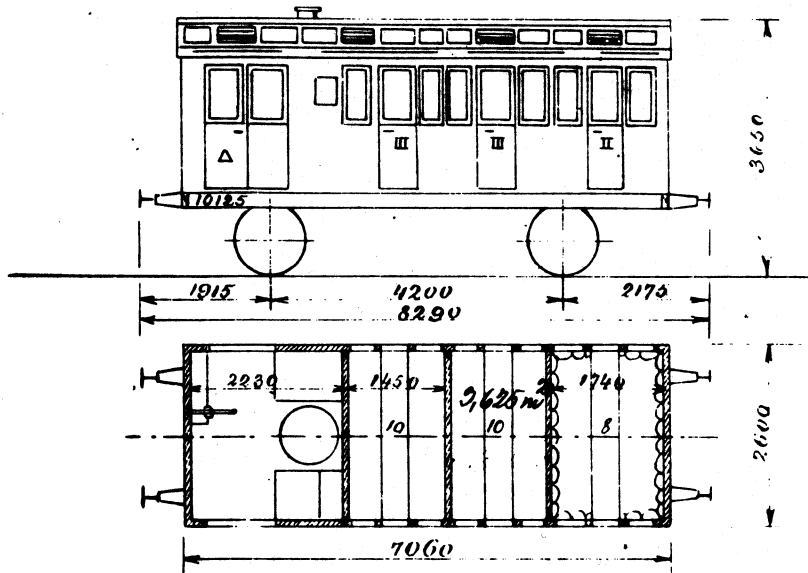

C
B.v. 66.

10.

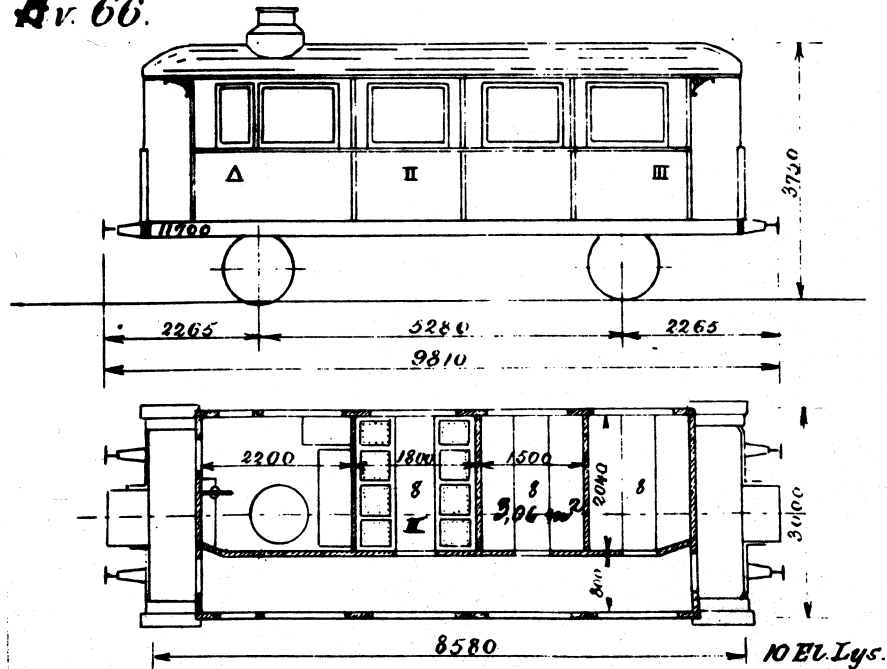

C. 68-70.

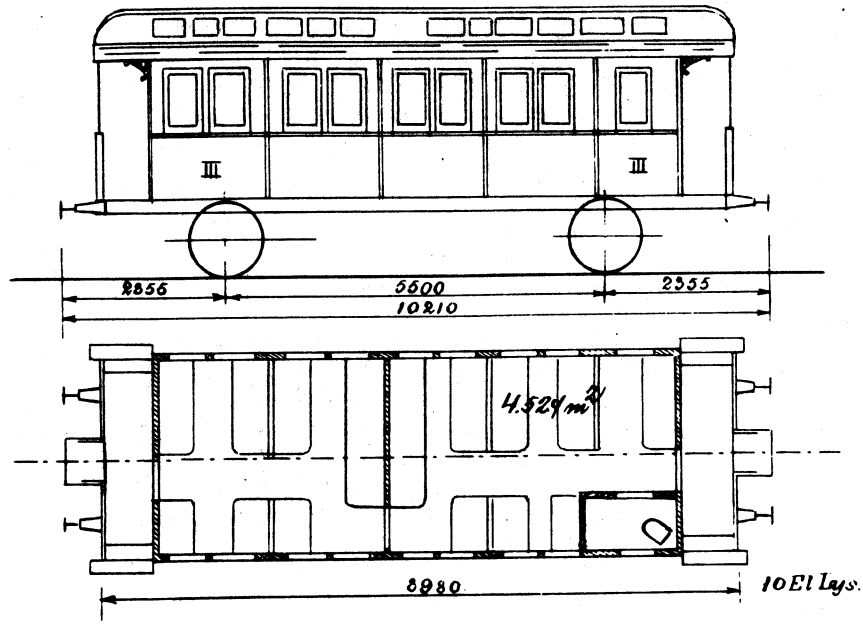

C. 71.

11.

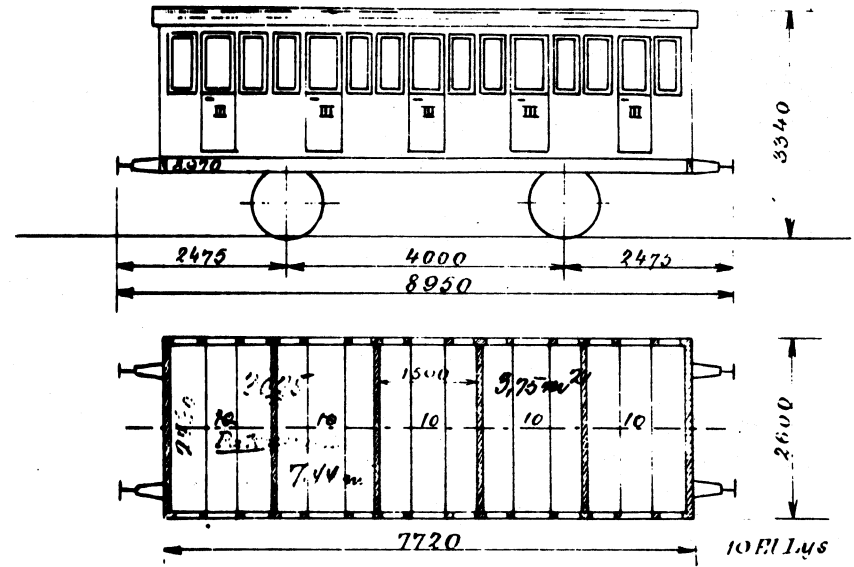

C. 72-76.

12.

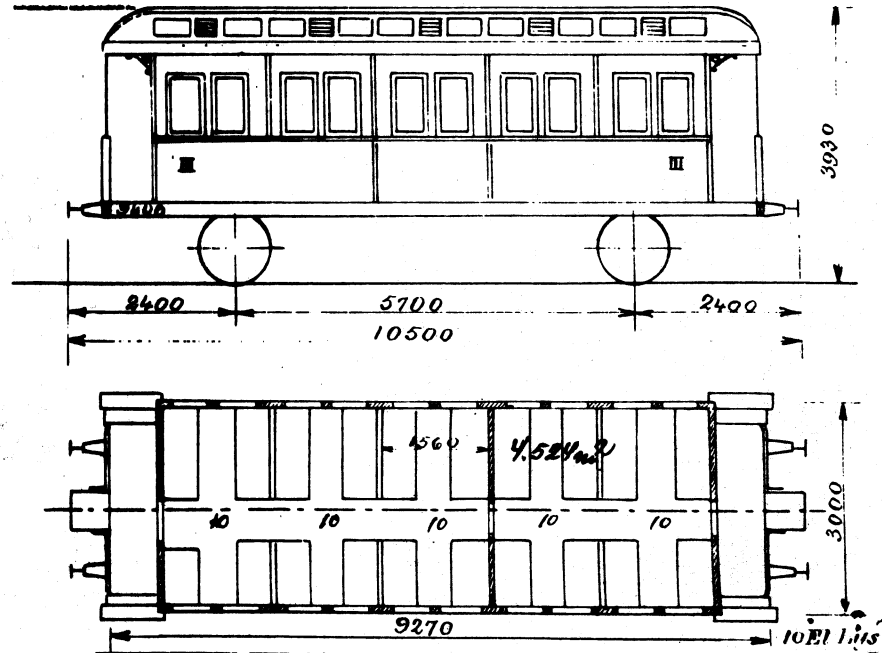

C 77-82 n 97-88 - Cf 195-196.

C 82
Scandia R252.

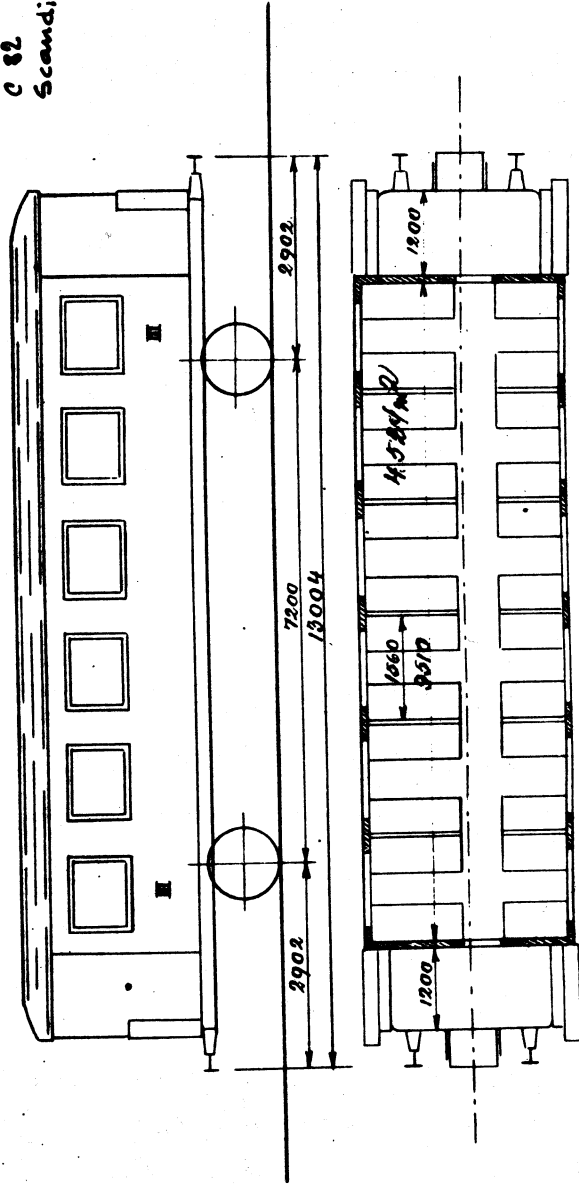

9654
 Undersjör i östra Rummet 14 El Lys.
 C 97-98 C 82.
 C 78-81

C. 195 v 196 har strömbussar.
 Vagnen har ståtbeställning.

C 89.
85-87.

13.

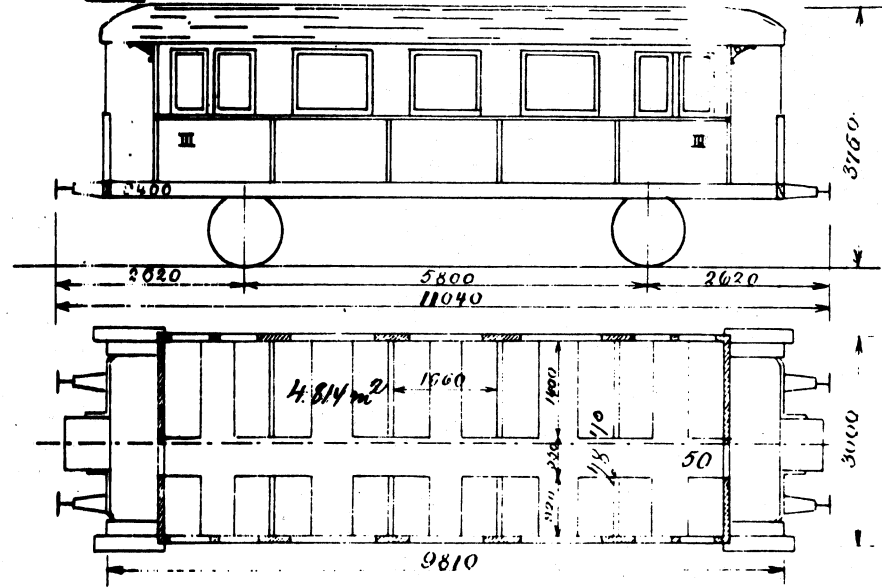

C 88.

14

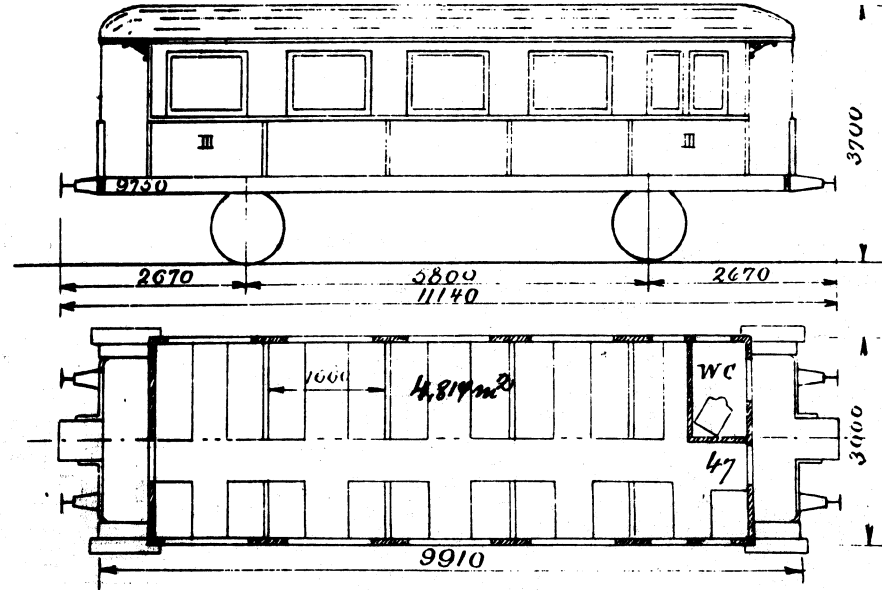

C. 89-84.

15.

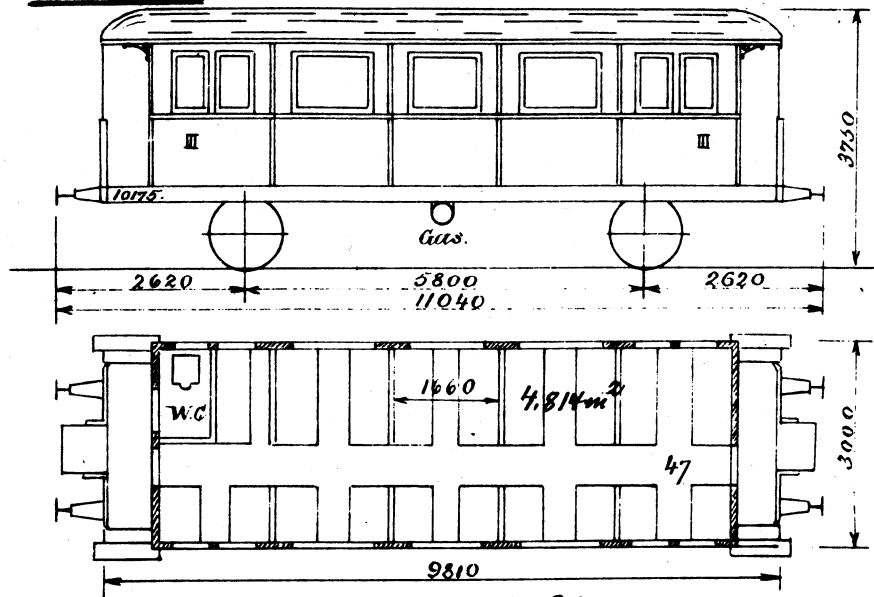

C. 84 har Petroleumsbelysn.

C. 91-94.

17.

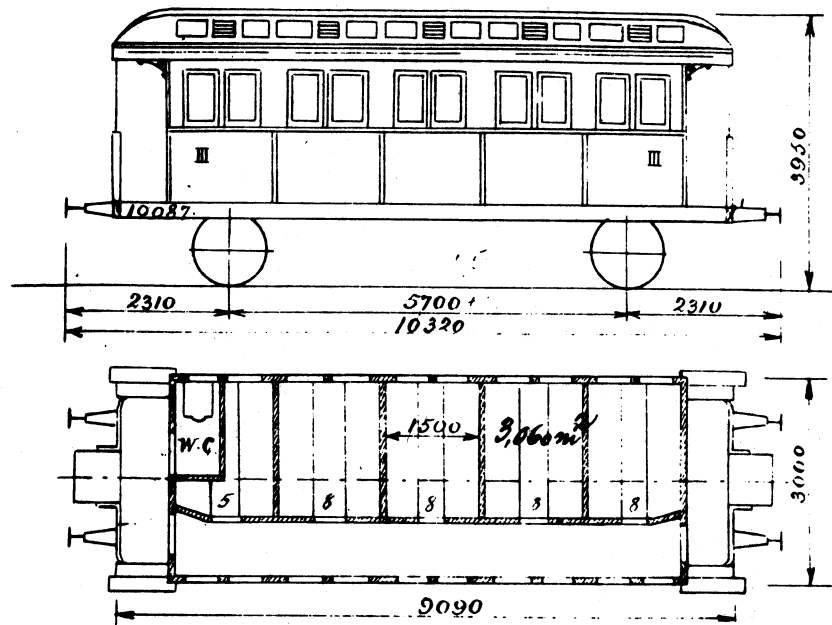

13 Pl. Lys.

C. 90. kravt 3/1228.

16.

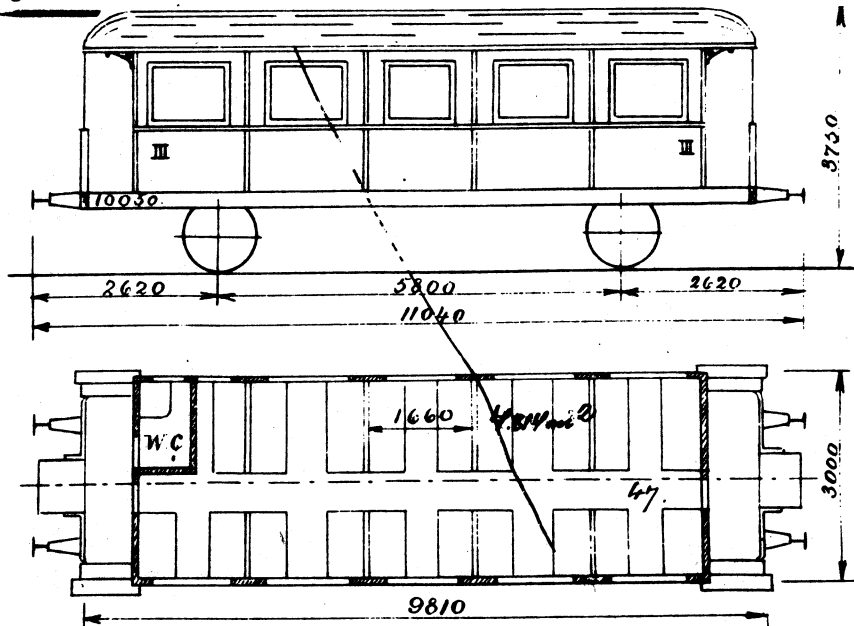

C. 95-96.

18.

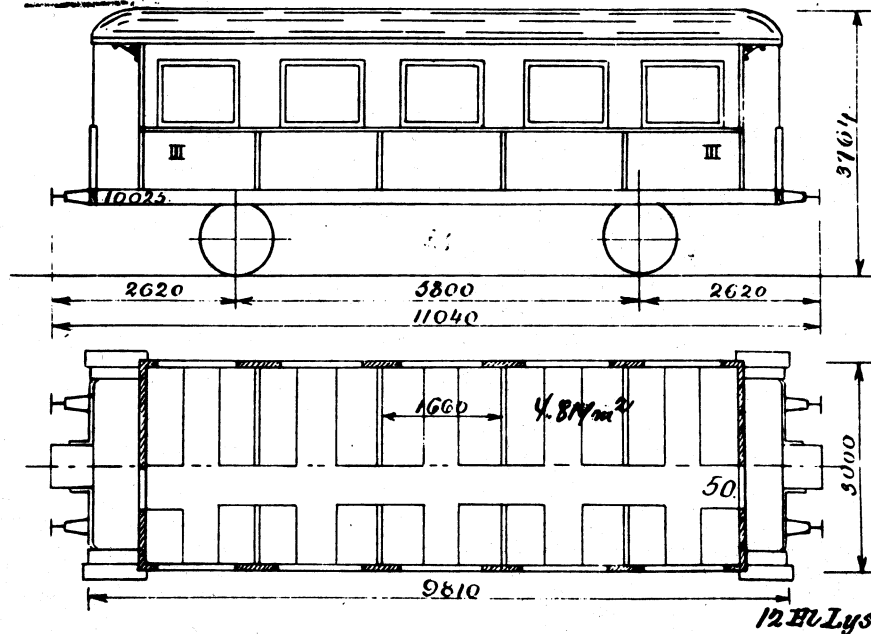

12 Pl. Lys.

C. 100.

Omb. Okt 1921 fra Kædebyggen.

C 100 Adg 1909, ex CV 100

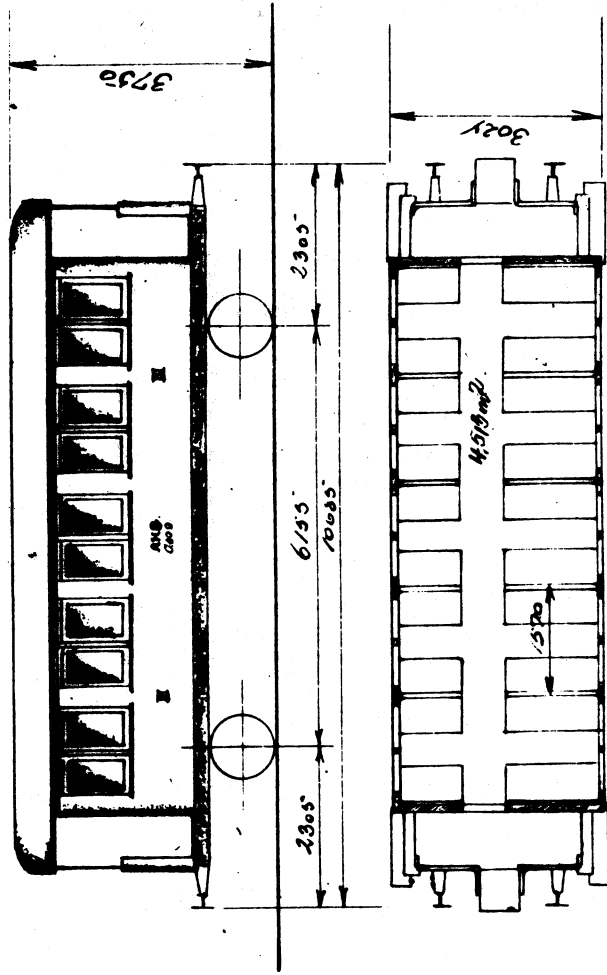

12 El. Lys

Tejntryk 999 44.

C. 99-100 ombygget i Okt 21. omstans til C. 100.

19.

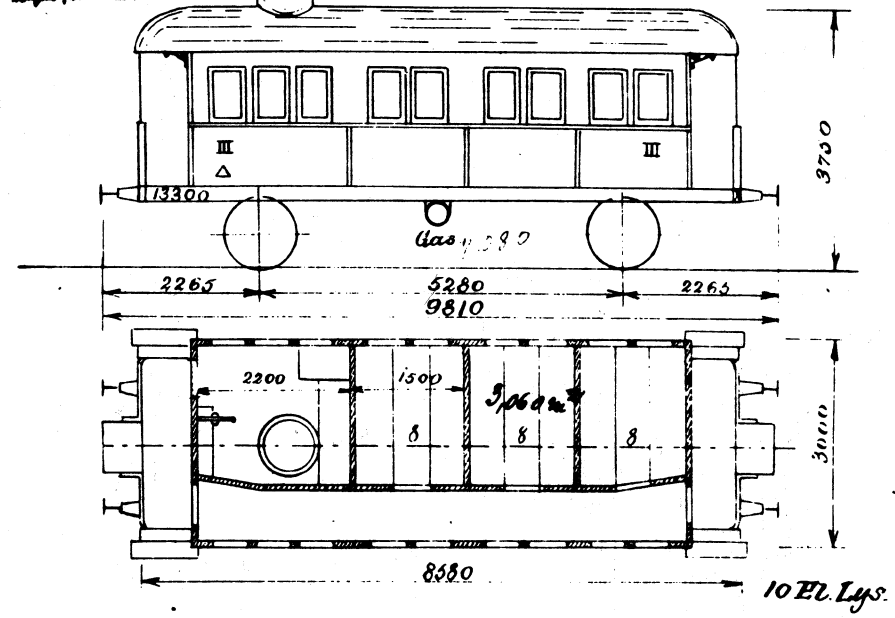

C. 101-106.

20

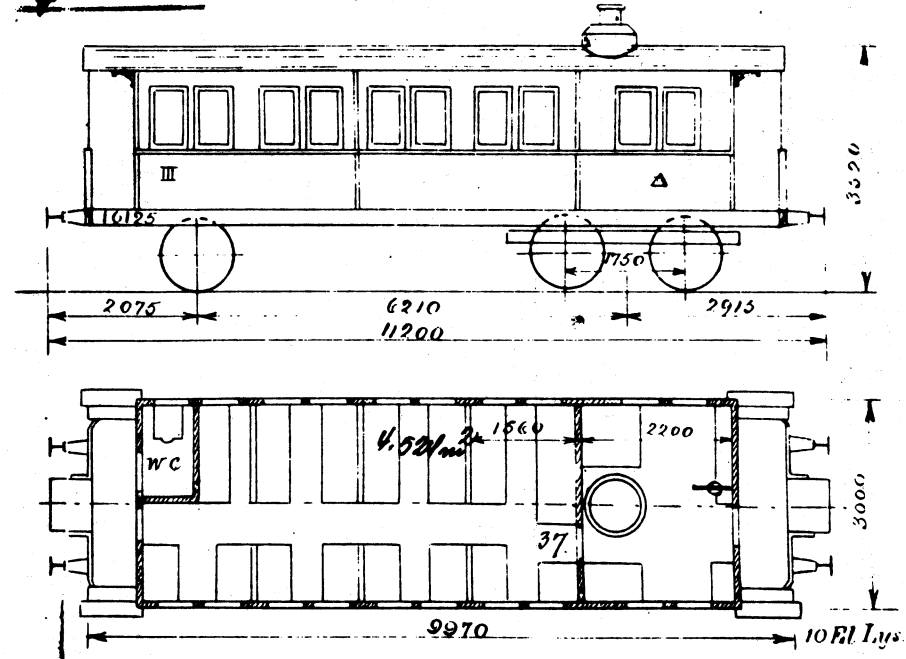

Cr 107, 108-109, 110-111, 108-109.

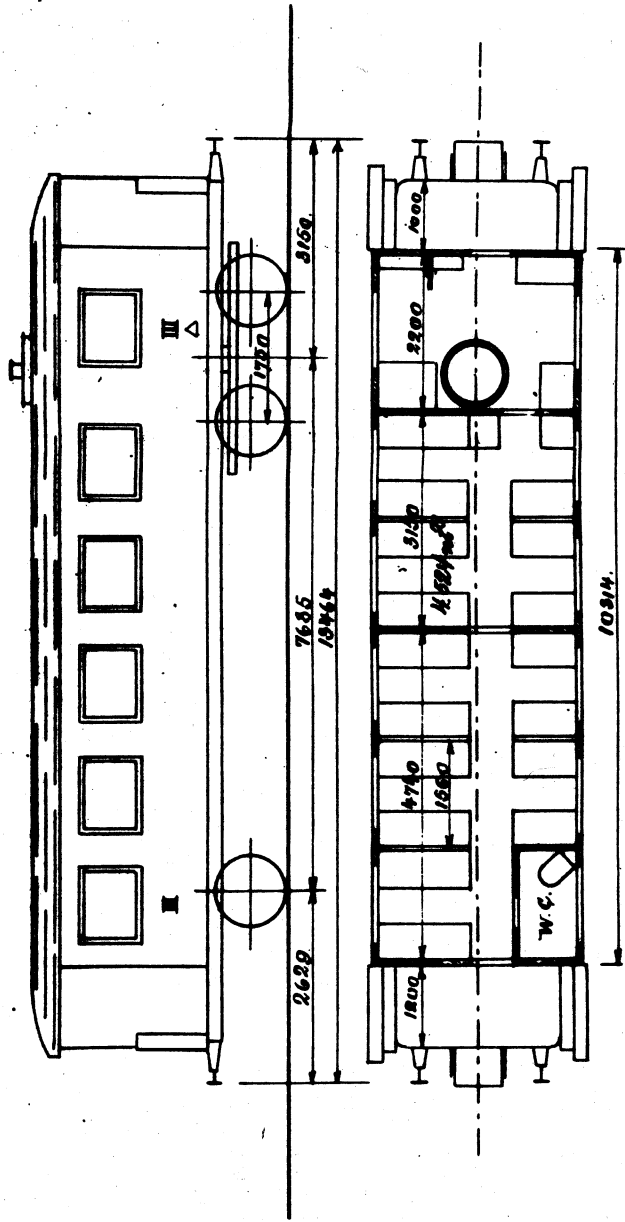

14 El. Lys.

*Cr. 108-109 has ingen. Stillenoren.
 Fachwerksbekleidung, Hindernis und Reservier.
 Schenkung p. Schenke.*

D. 121-122. C 121-122

21

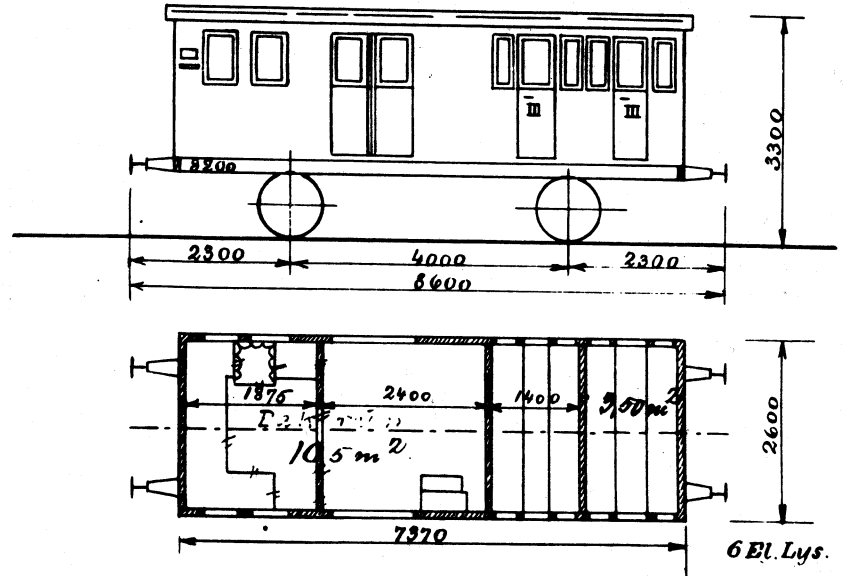

11 El. M. Lys.

D. 123-125

22

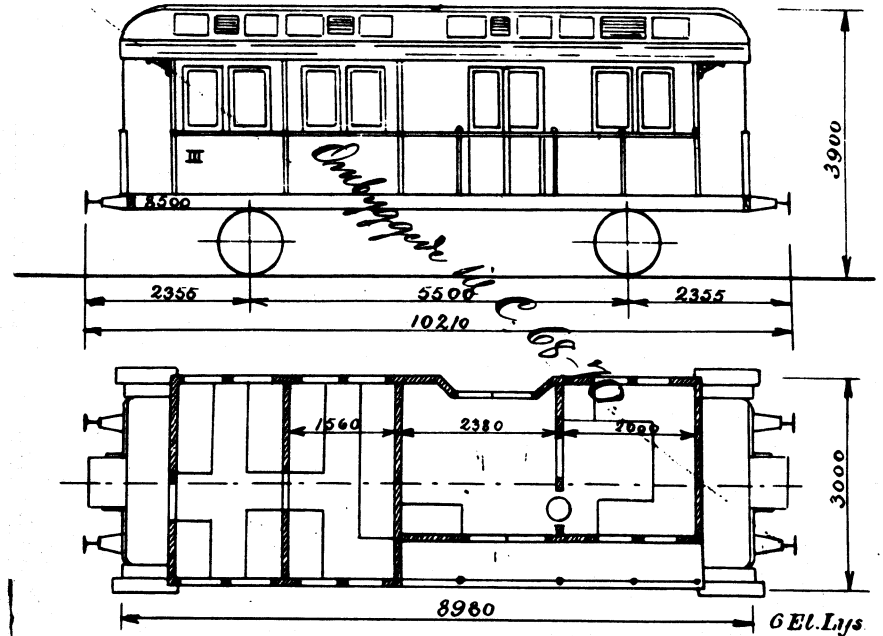

D 143-45

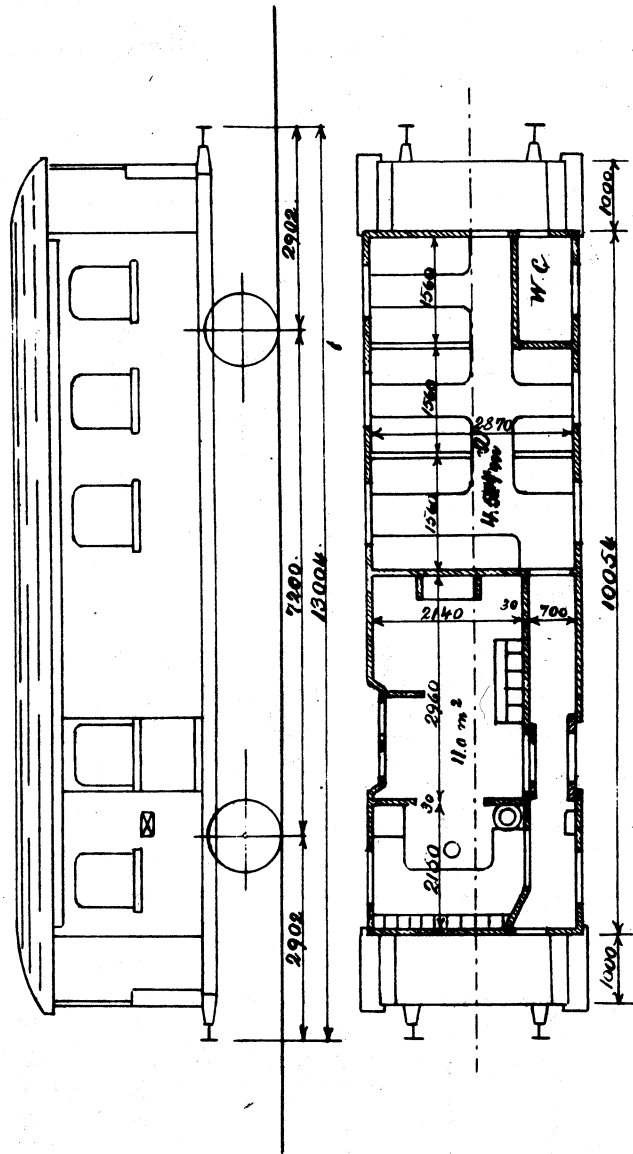

12 El. Lys.
Petroleum.

Vandretur inden Rummet
D. 143 har tillægget af W.C. er rindes. H. Jørgensen (1929)

E. 161-162.

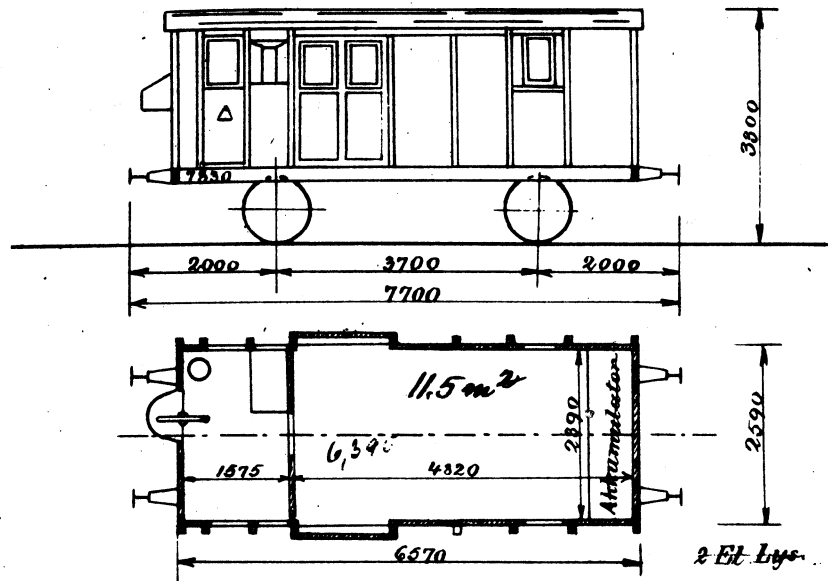

E. 163.

161: 12 Volt Akkumulator og
dynamisk
Kraftledning.
ansluttet i Aars.

26

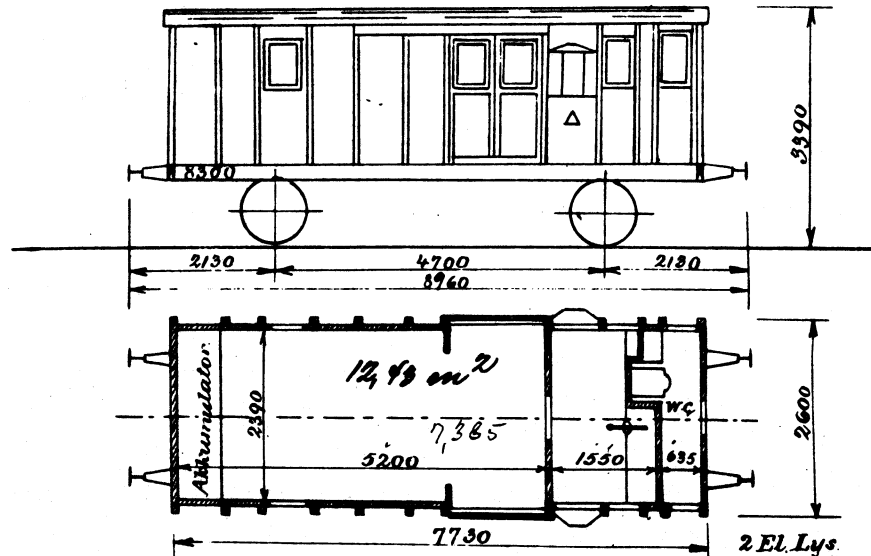

E. 164-165.167.-170.

27

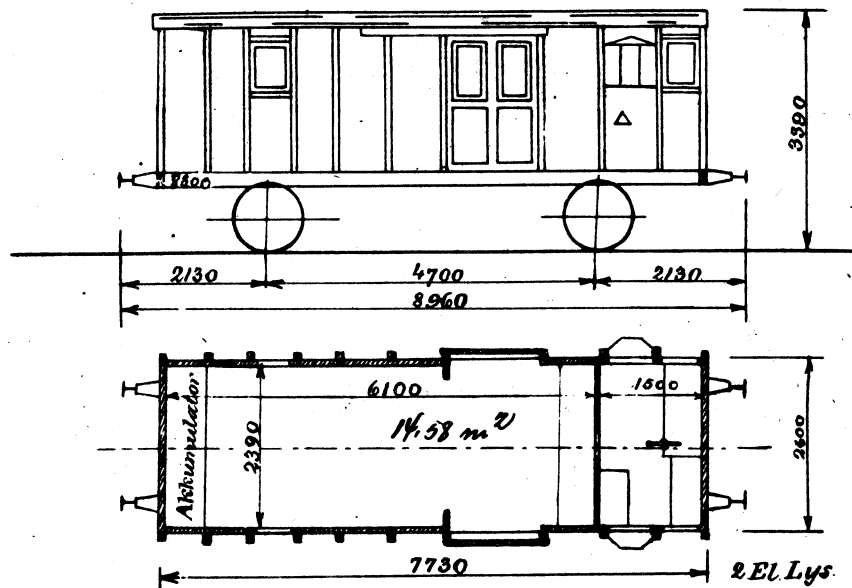

E. 171-173.

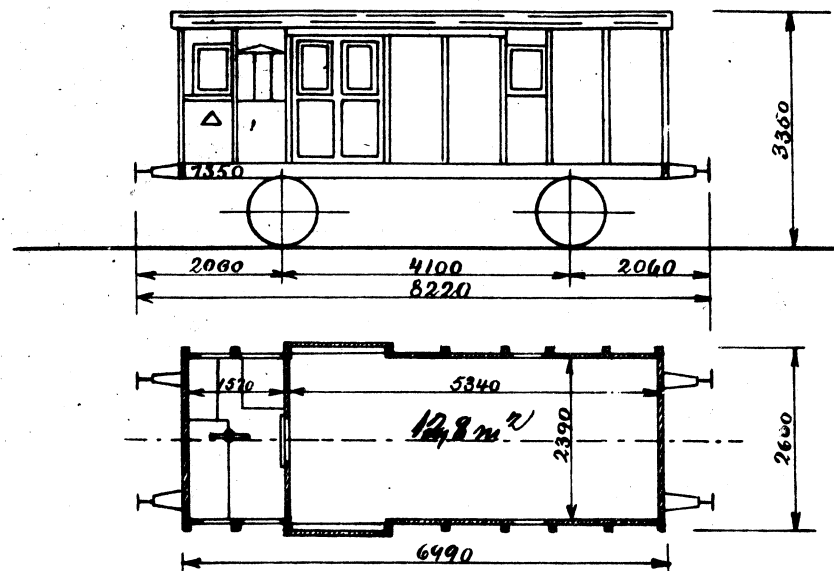

E. 166.

28

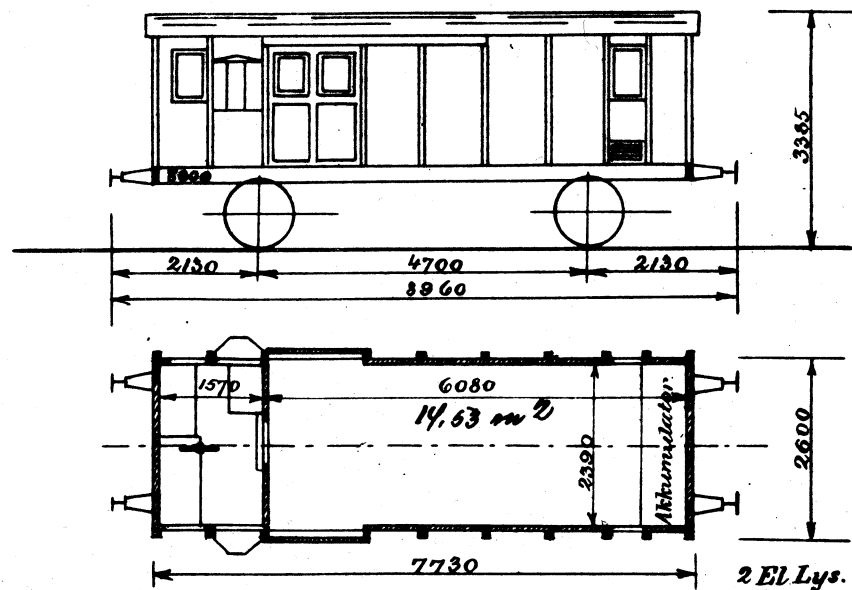

E. 181-183.

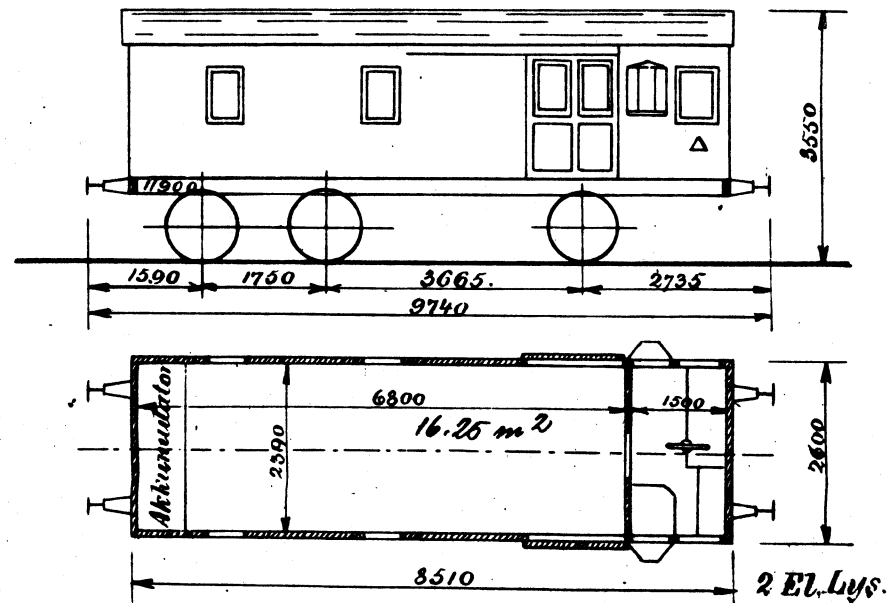

E. 184.

31.

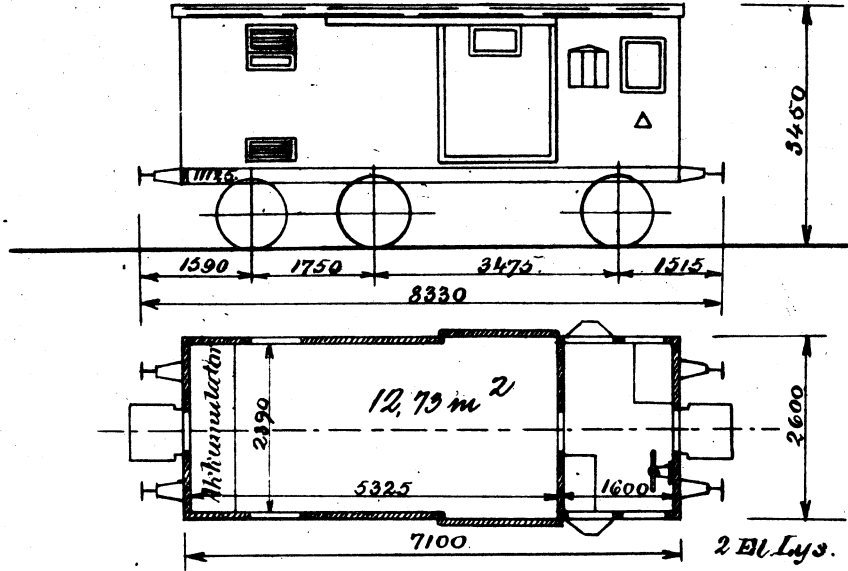

M. 1101-1204

6

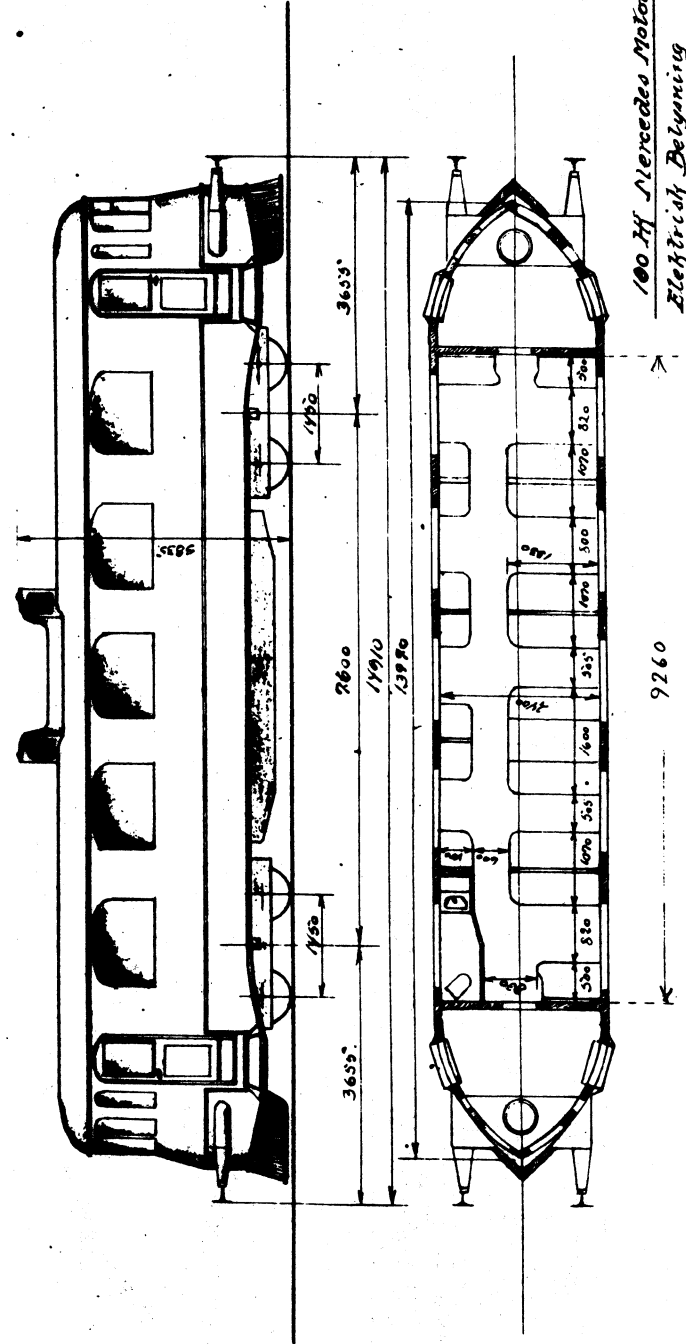

Teodoro J. I.

M 3201. AKB

7

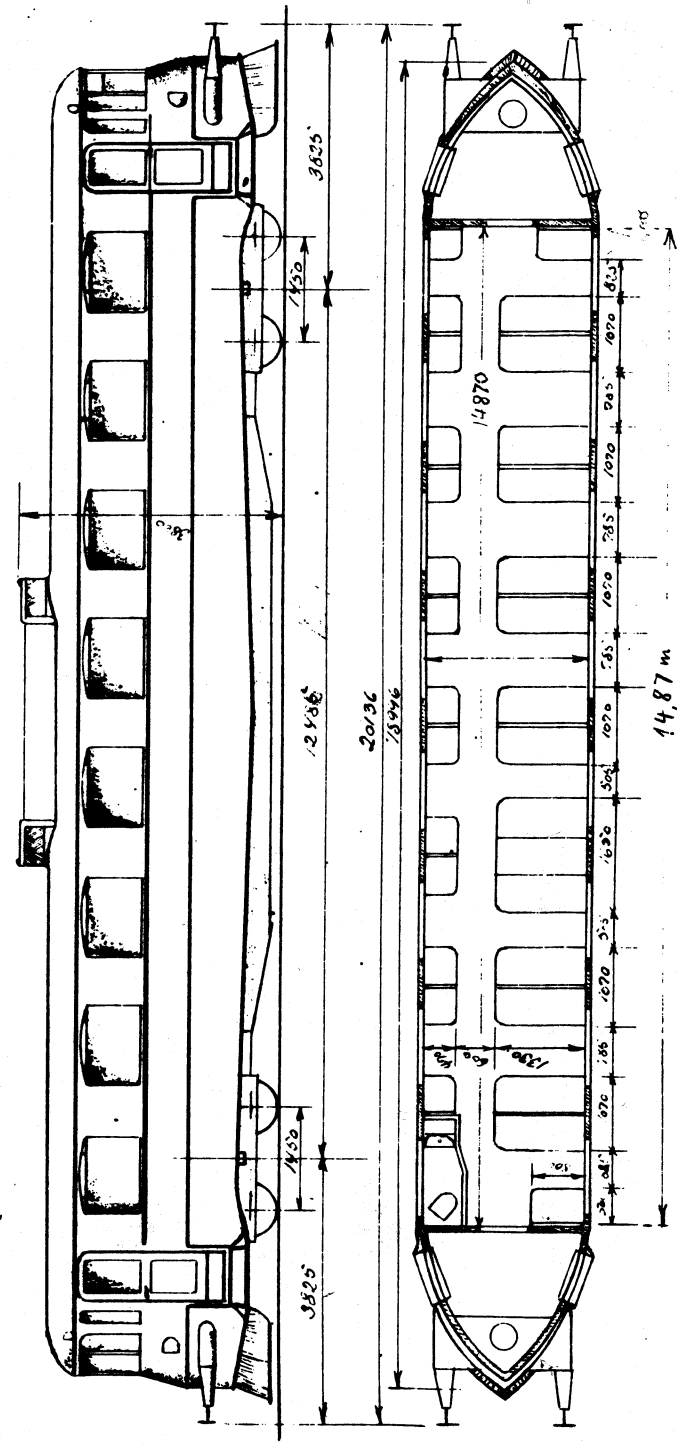

200 Hk Mercedes Motor
Elektrisk Belygning

Tegning J.22.

32.

Q. 201-205.

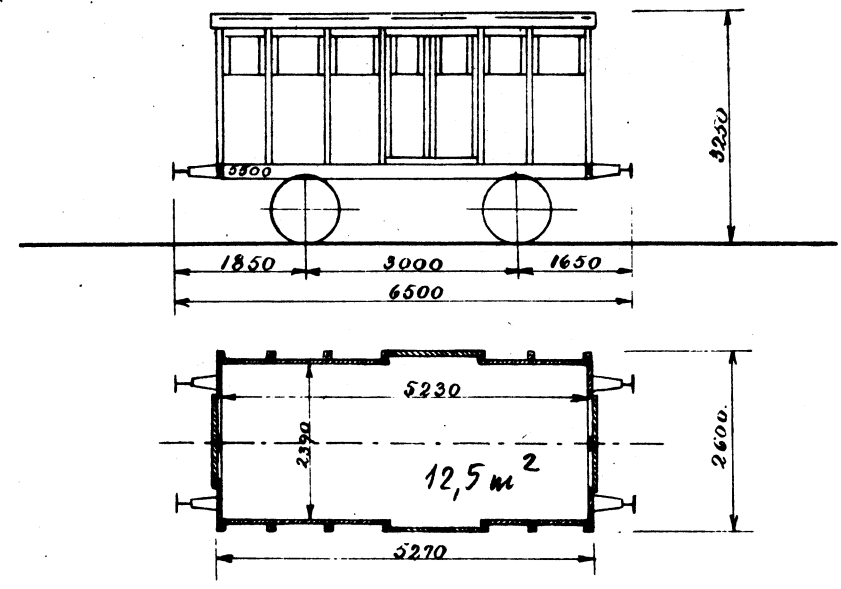

Q. 206-233.

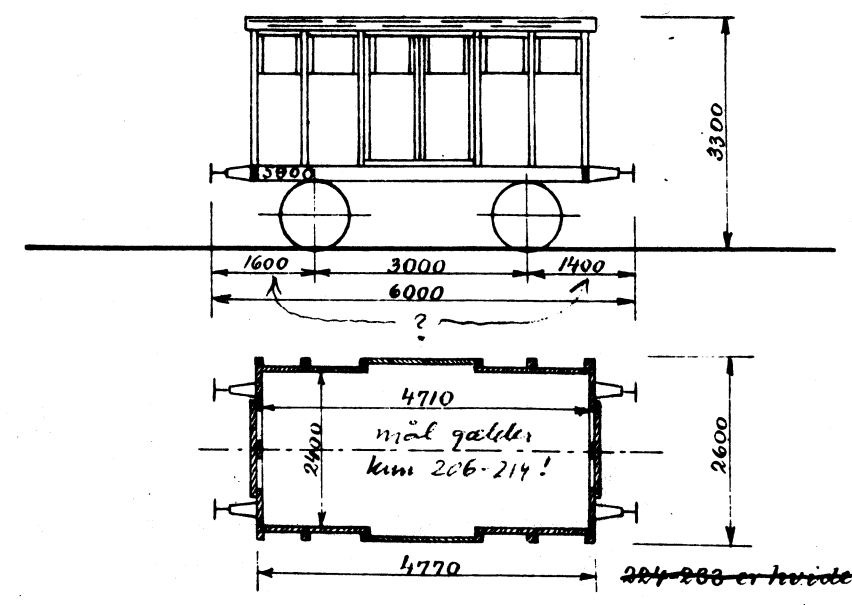

33.

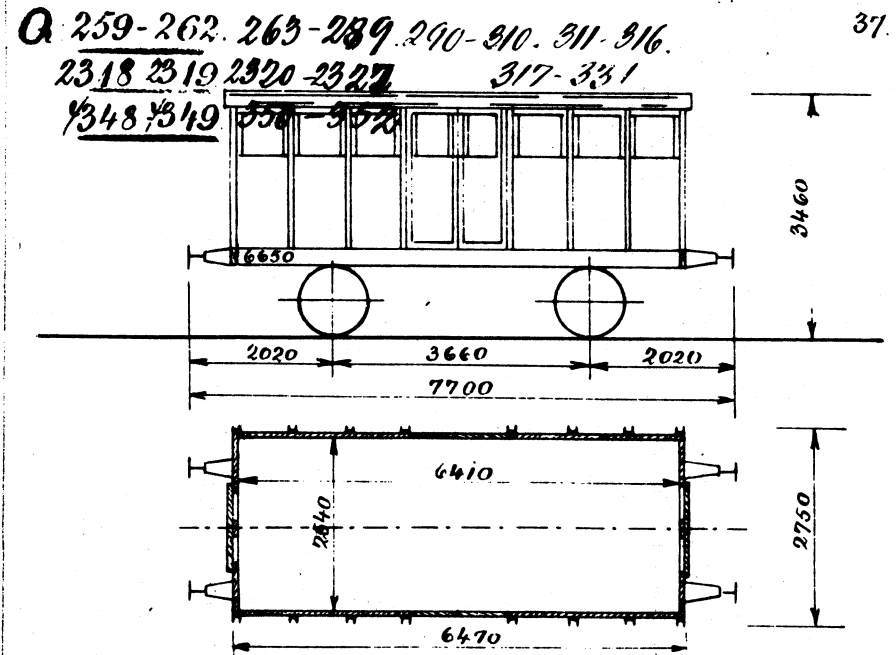
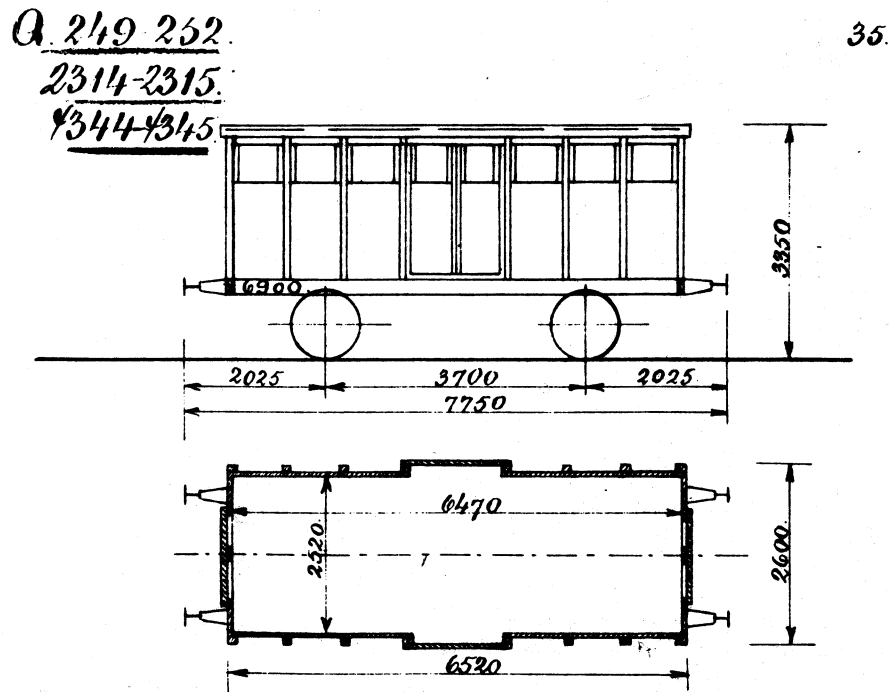
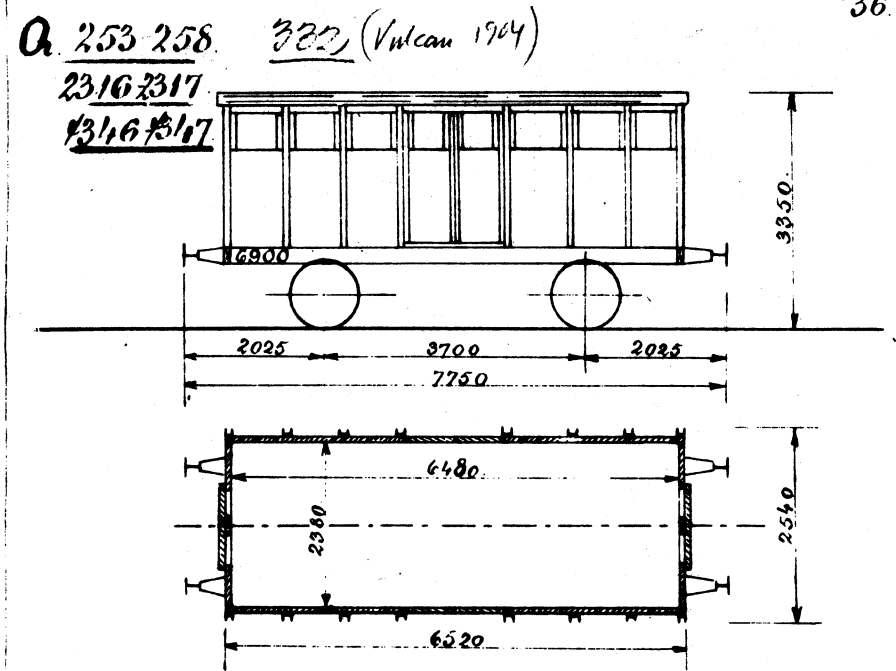
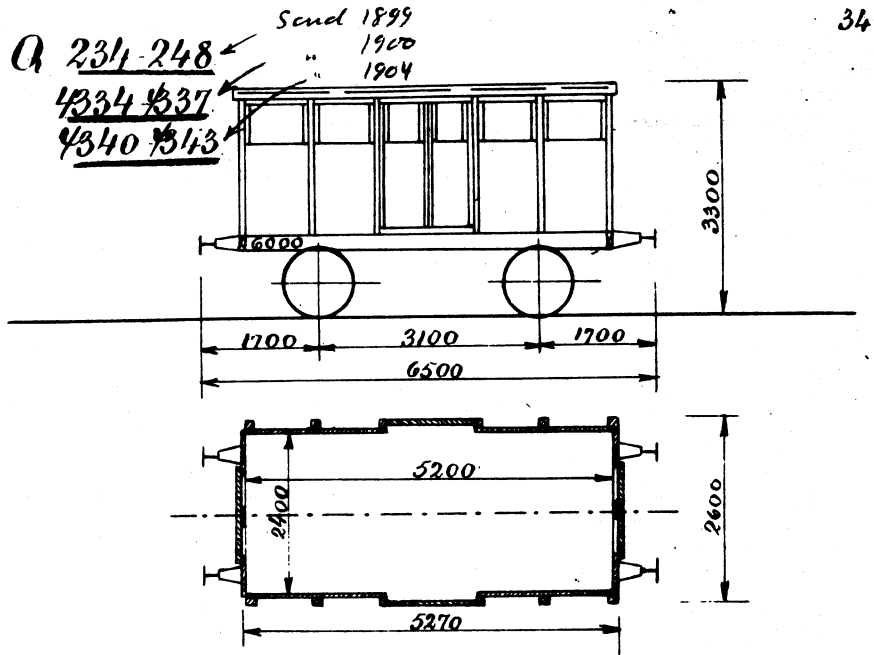

Q23012303
23102311.

ej dør i denne side

38

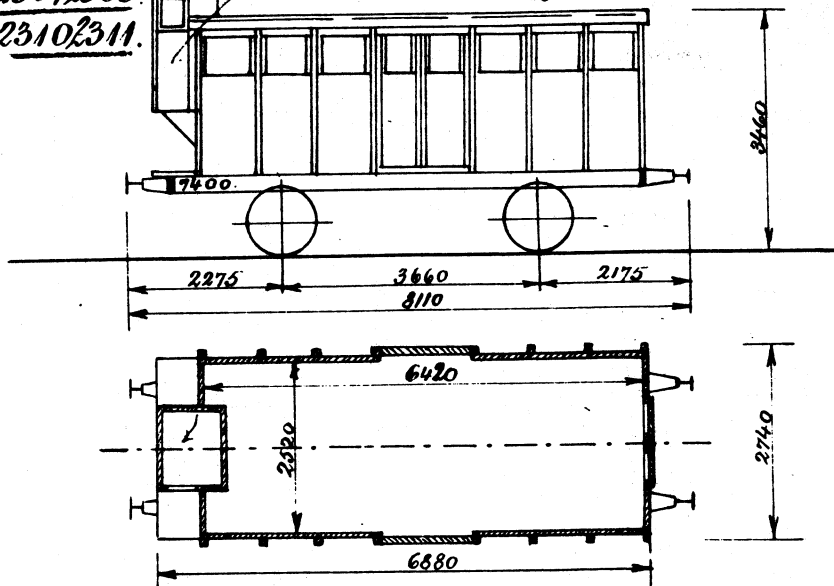

Q43314333
43384339

Sæd 1900
Sæd 1904

40

døren var i den anden side!

mid fra Sæd-kegn nr. 6886

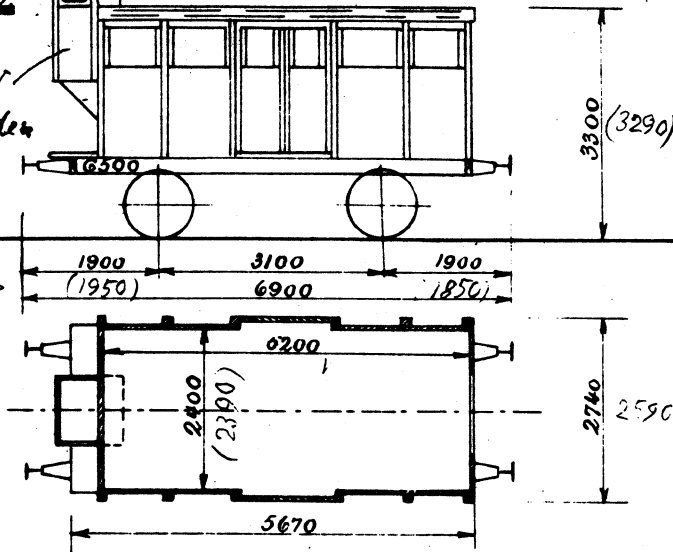

Q23042309
23122313.

39

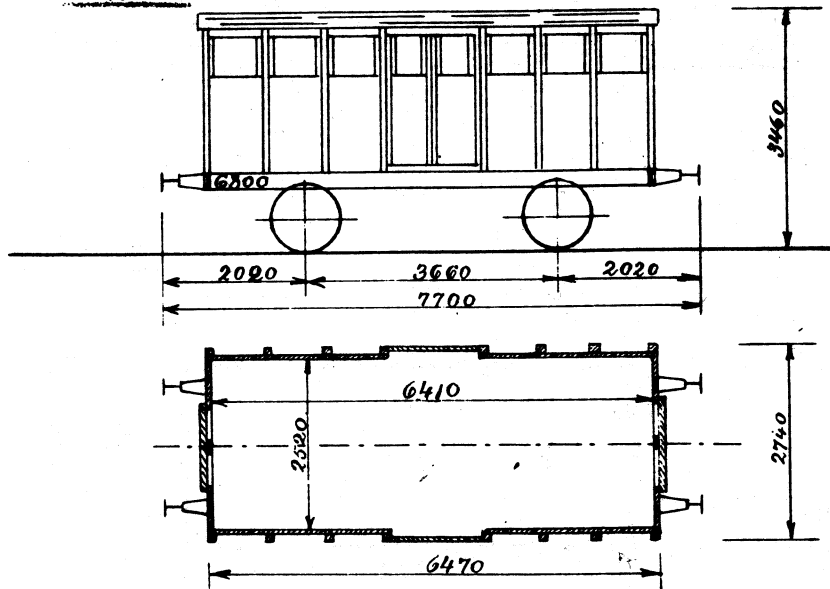

H. 400-413
24212427
44314437.

41

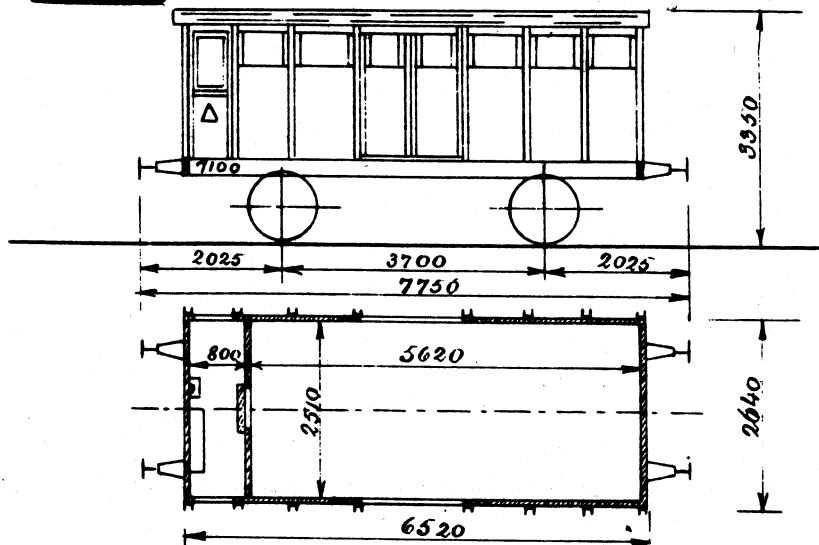

412, 413, 423 og 433 have høje siderumme.

H. 414-419.

42

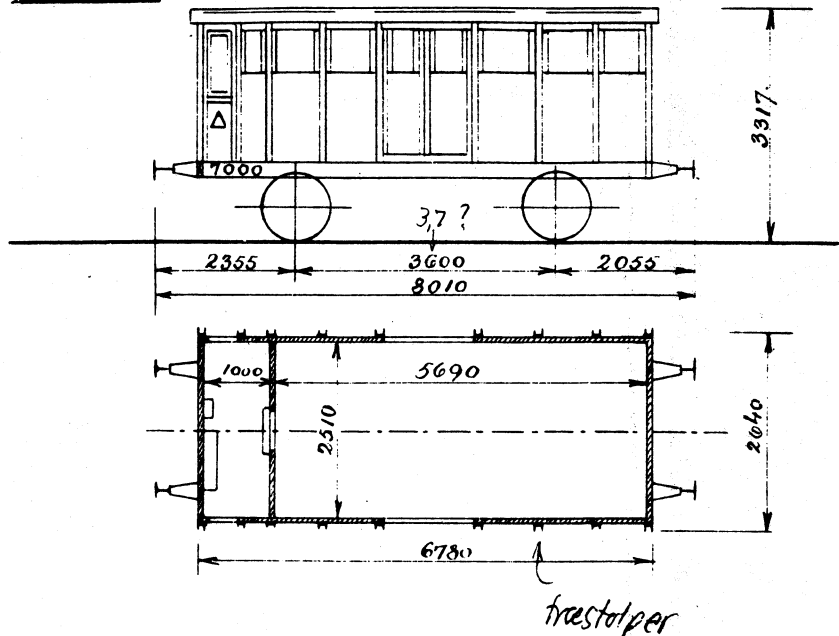

Q. s 461-464.

44

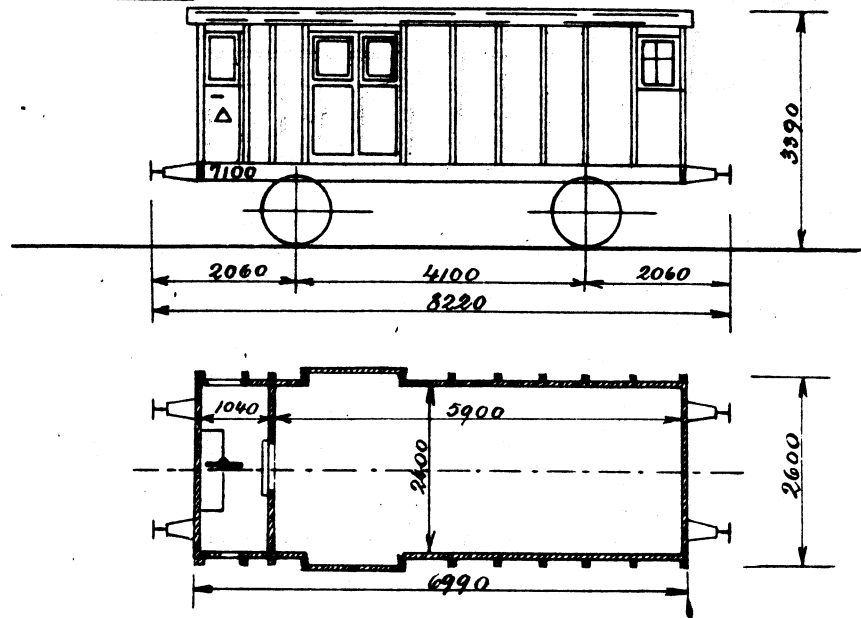

Q. s 441-446.

43

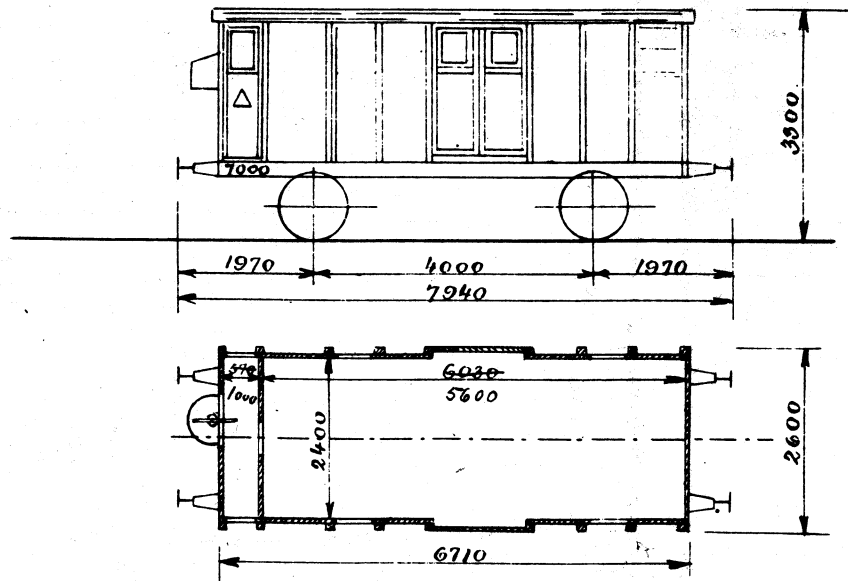

H. 501-508.
2531-2532.

45

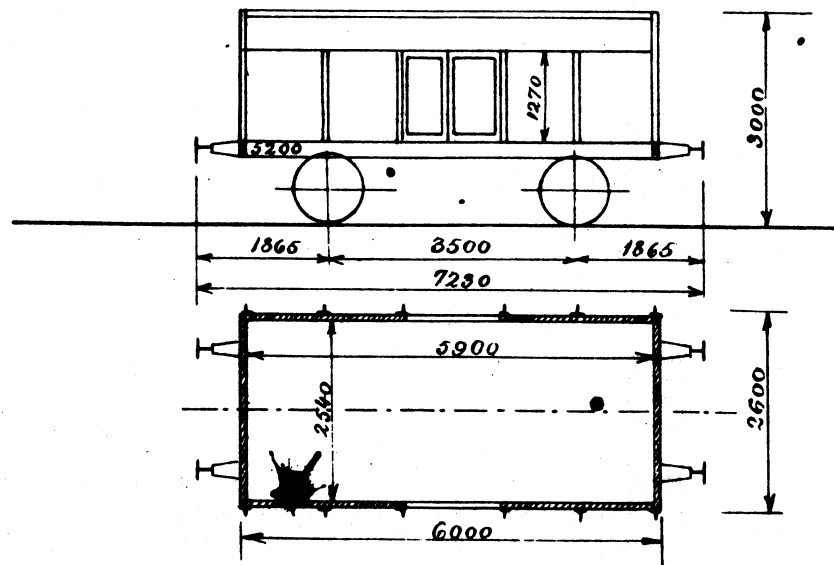

46.

K 505-512 509-512.

2533 2534
4541 4544.

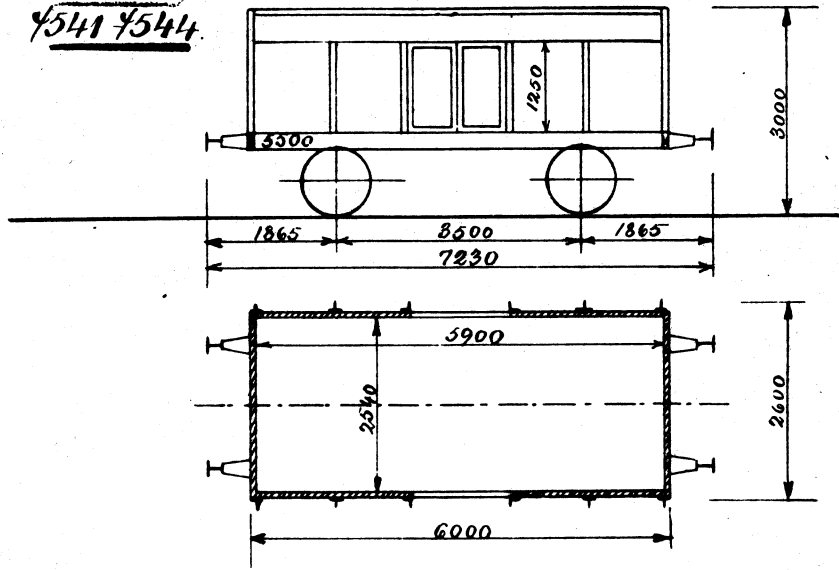

P 603-612.

48

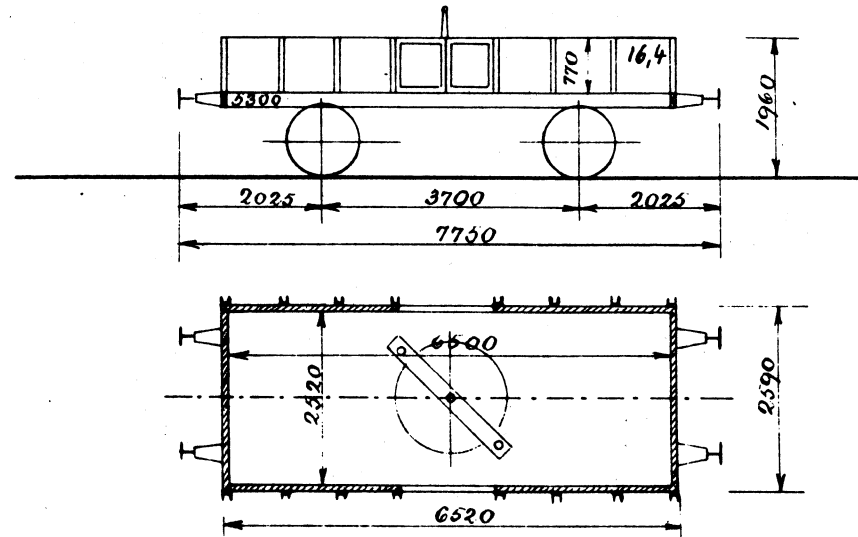

P 601-602.

47

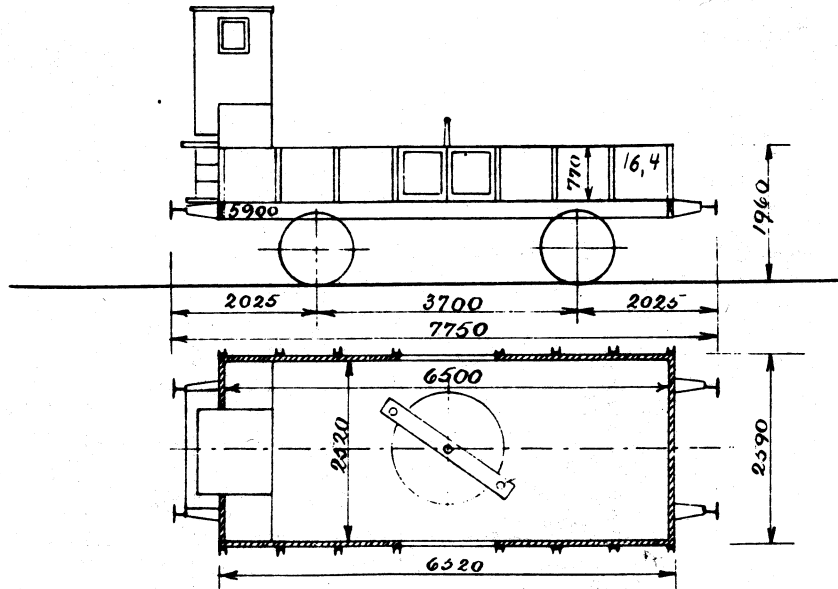

P 616-623.

49

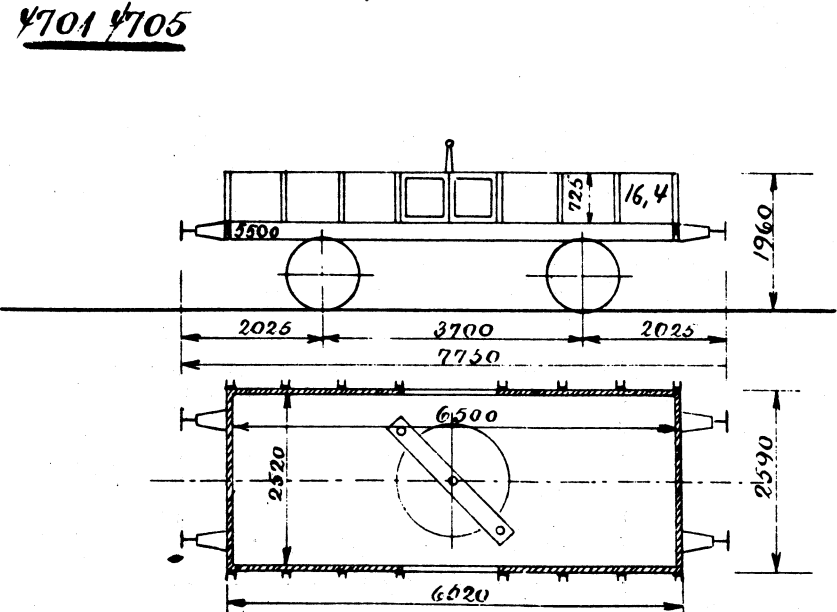

P2671-2672

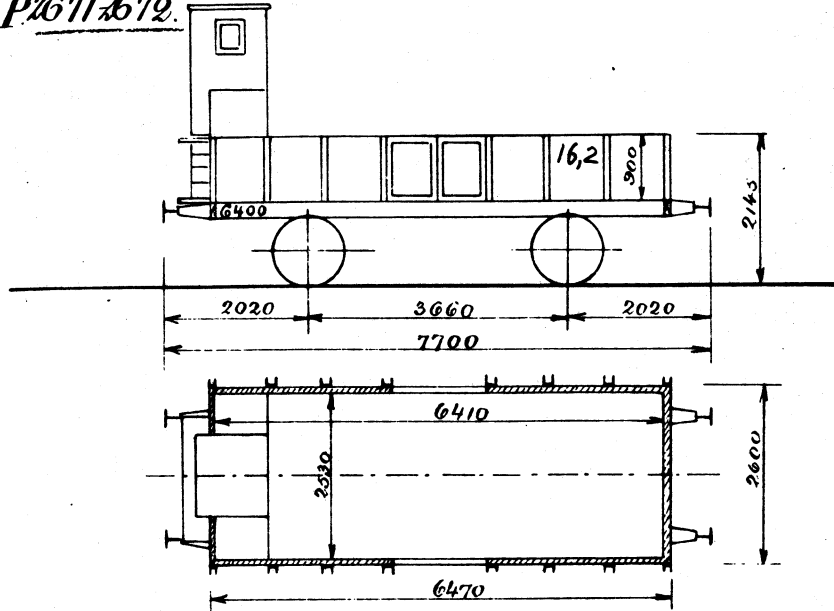

Pb. 771

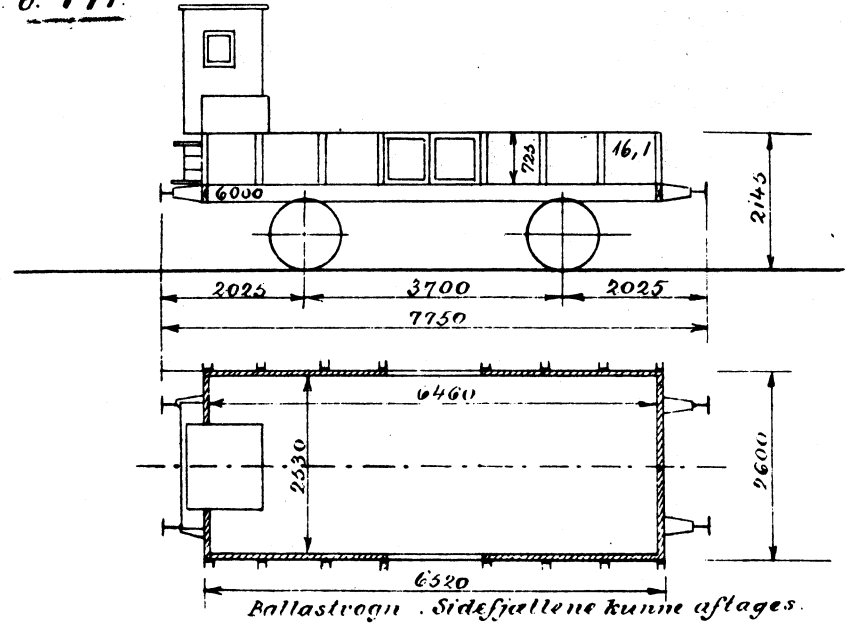

P2673-2676

677-678

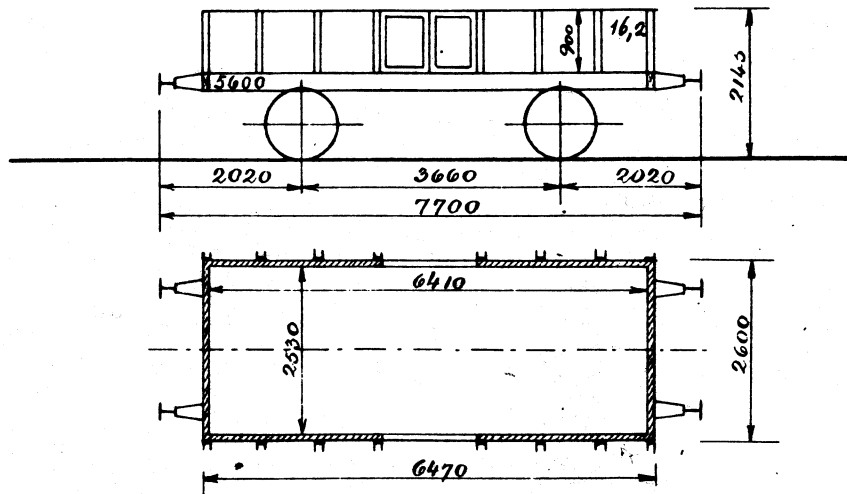

Pb. 772-780

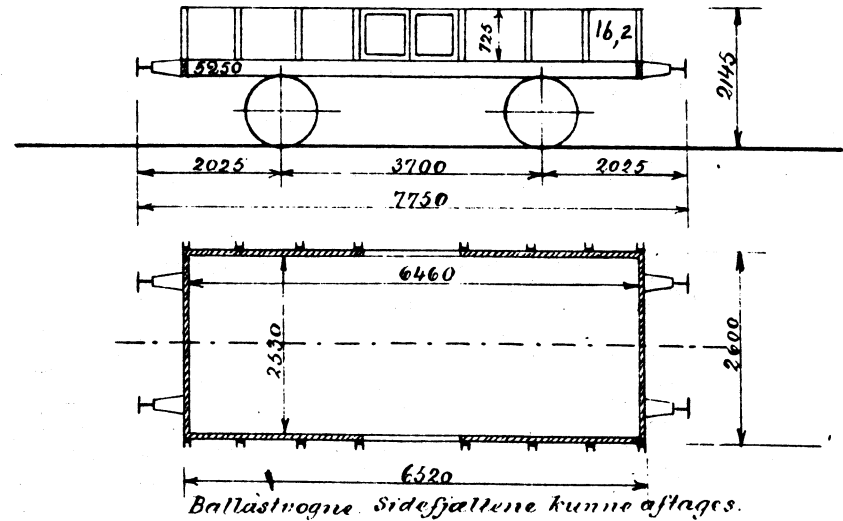

P.l. 801-823

~~4861-4865~~

~~4871-4875~~

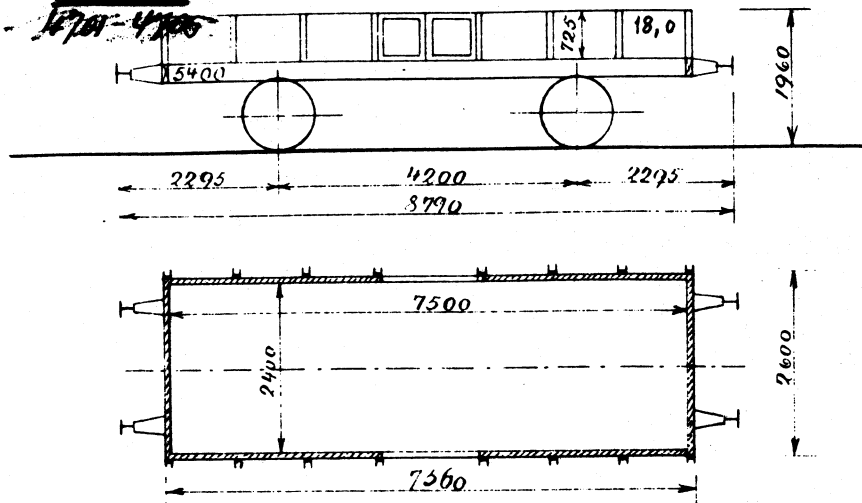

P.l. 826-843

~~4866-4871~~

~~4873-4874~~

2892.

866-871 har 840mm høje Sideffjælle.

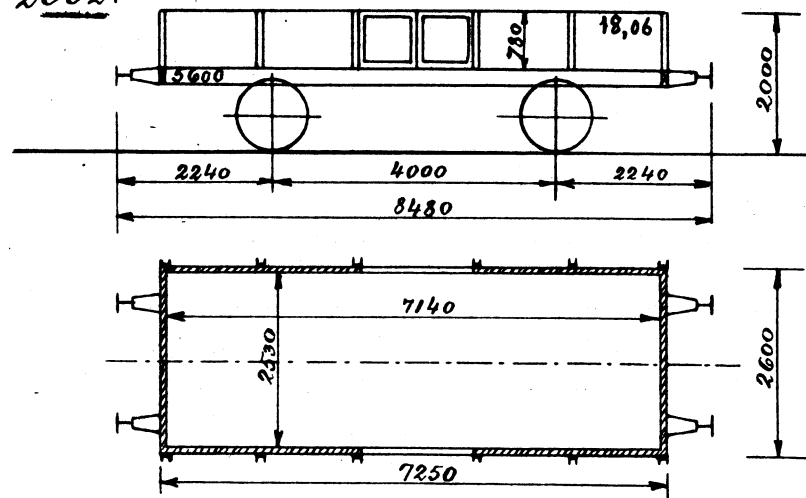

P.l. 824-825

4879

2891.

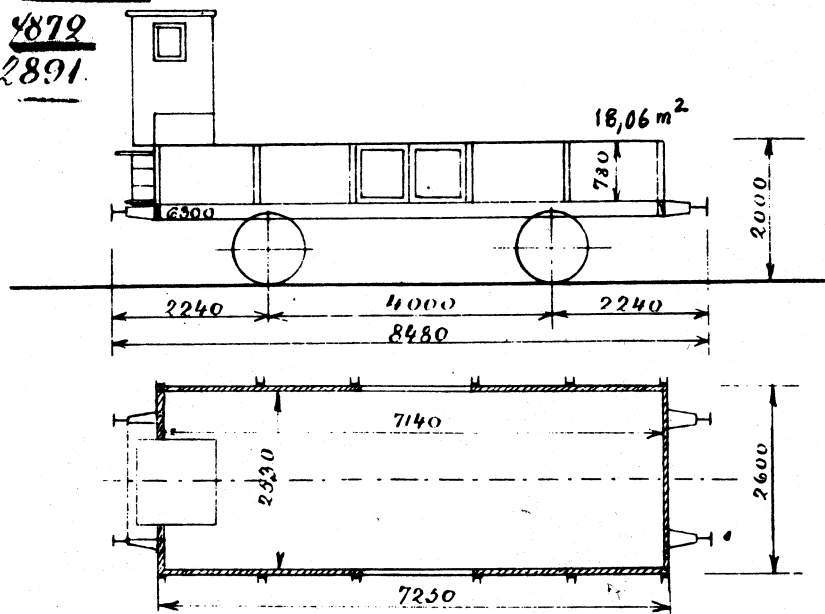

P.l. 844-849

854-855

~~4875-4876~~

4882

2893-2894

2897.

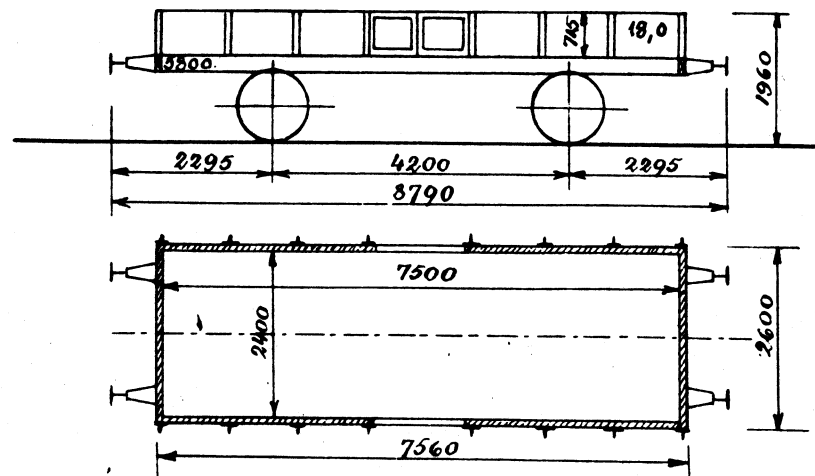

P, 1301-1310.

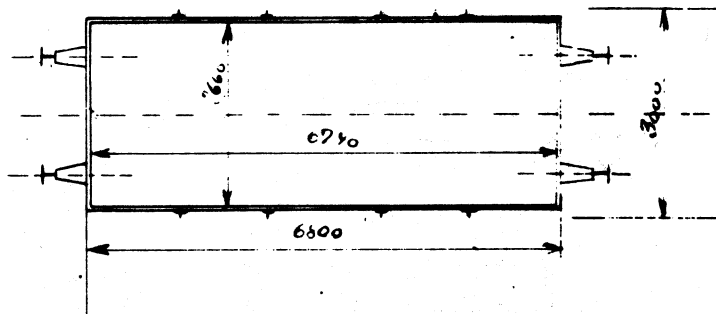
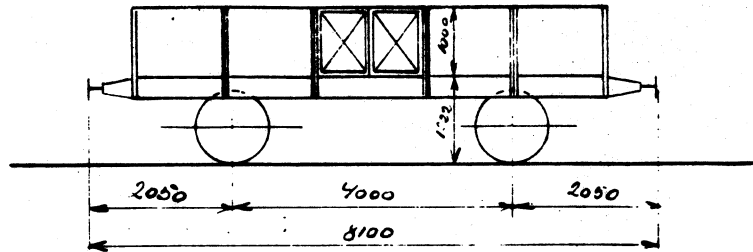

Pl. 850-853. * 856-859, 860, 951-966.

58.

~~4877 4878. 4879-4881. 4883 4890. 4921 4923.~~
~~2895-2896. 48898-2899. 2900 2904 2905 2907.~~

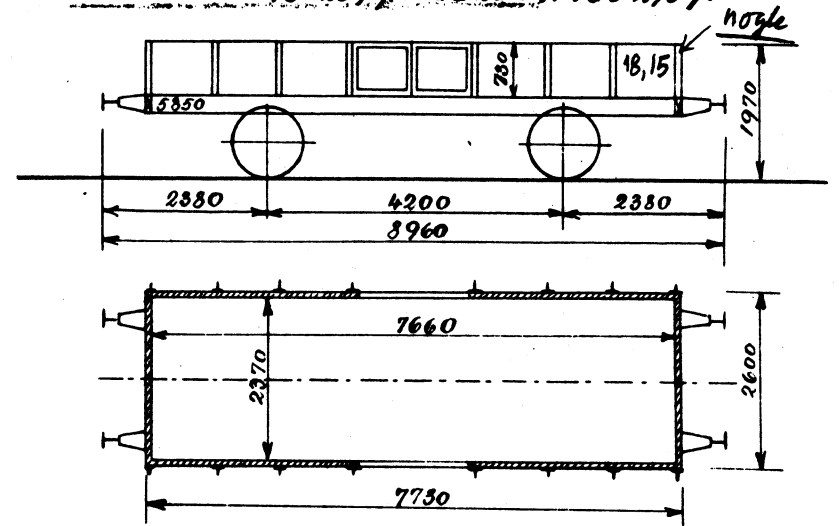

T2001-2004.

59.

1009-1015.
3005-3007

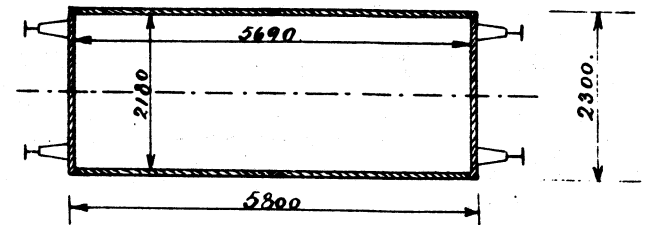
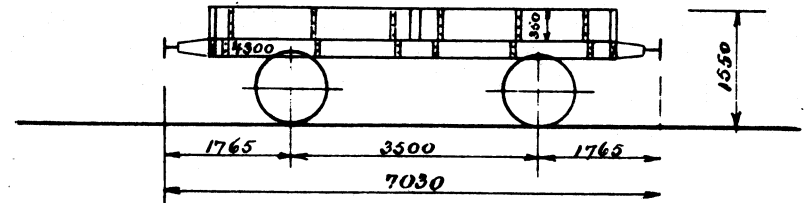

T. 0008
1016.

60.

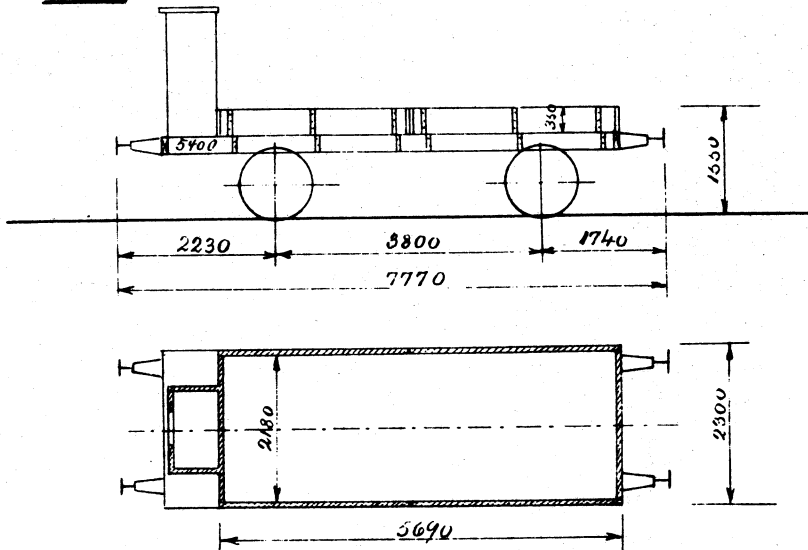

T. 1029-1052.
5009-5020.

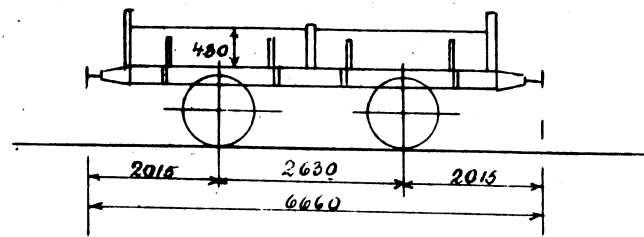

T. 3017-3022.

61.

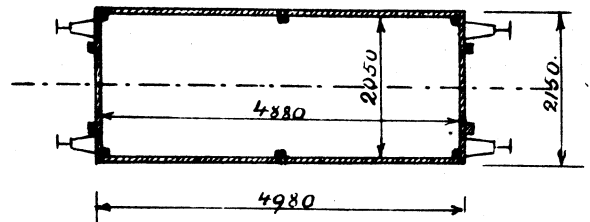
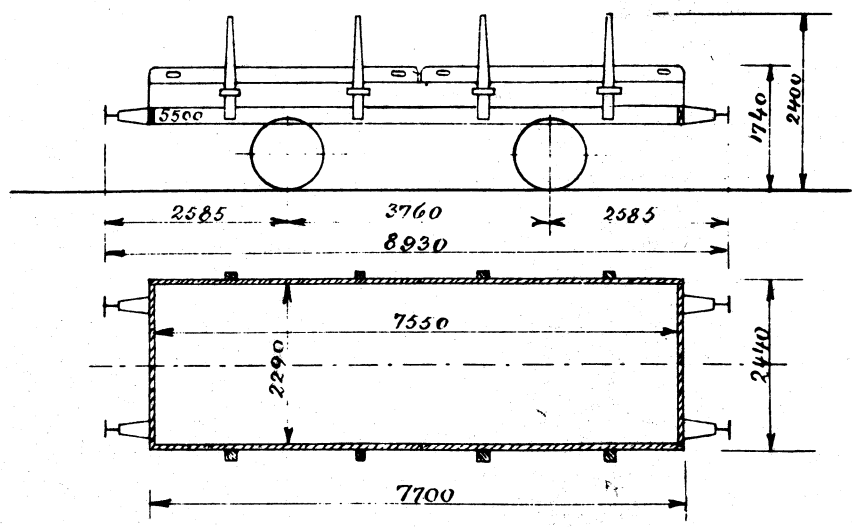

T 2023 . 2029.
1024-25. 1027-1028.
1026. 1030 .

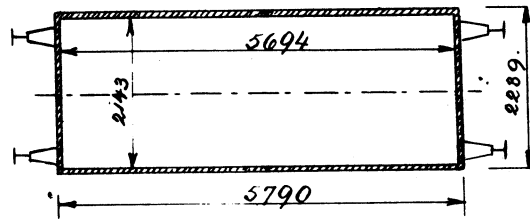
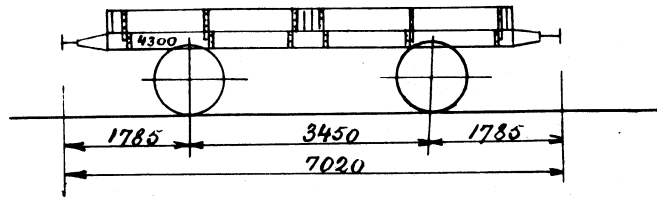

J. 1101-1116.
1141-1148.
1171-1178.

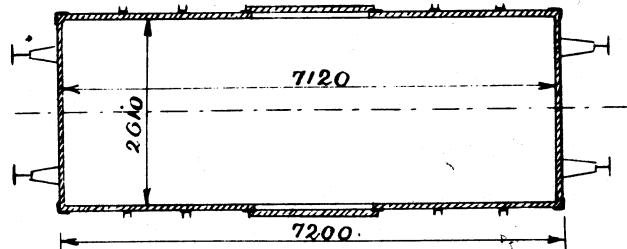
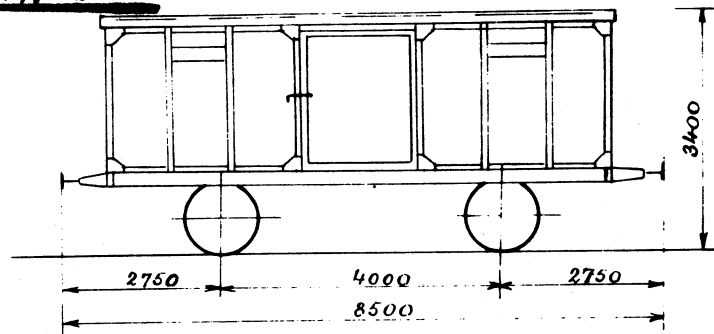

1. Handwritten title
 2. Handwritten subtitle
 3. Handwritten text

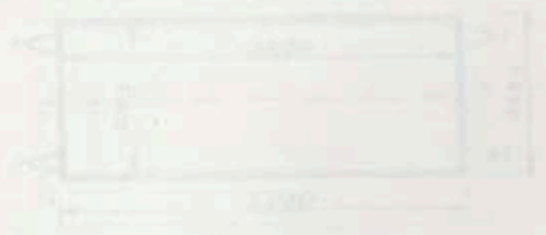

4. Handwritten title
 5. Handwritten subtitle
 6. Handwritten text

