

C. 191-192.

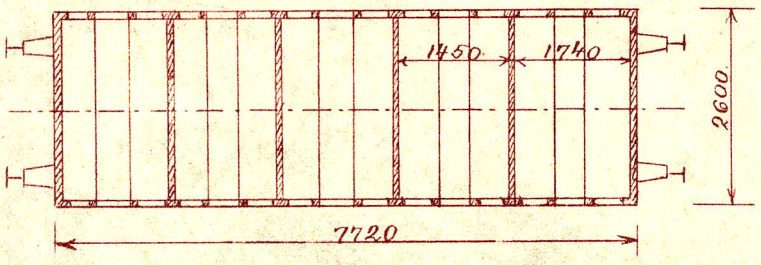

D. 123-124.

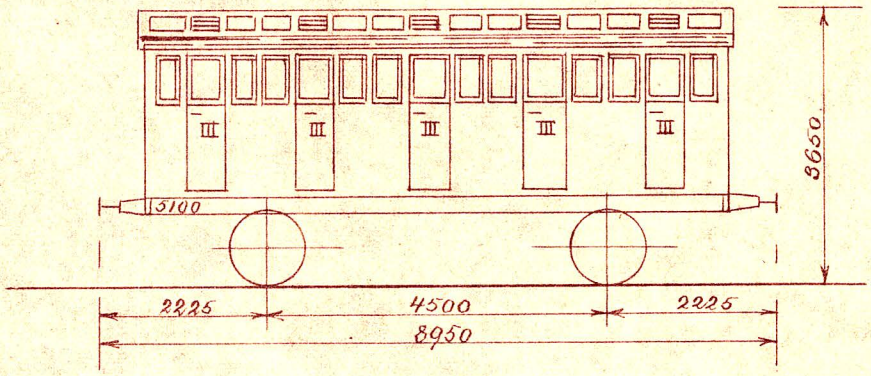
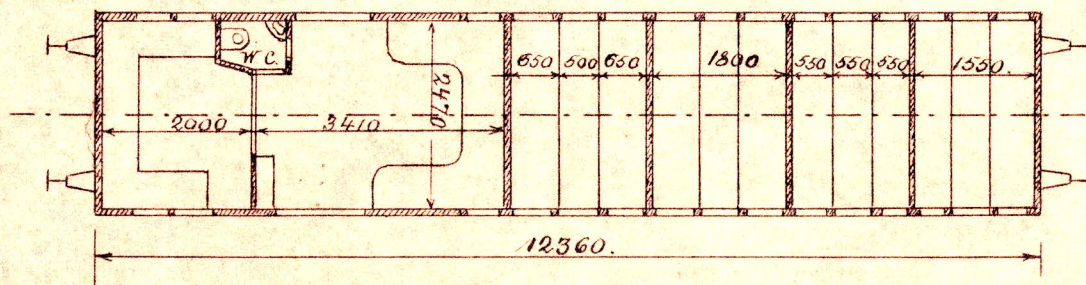
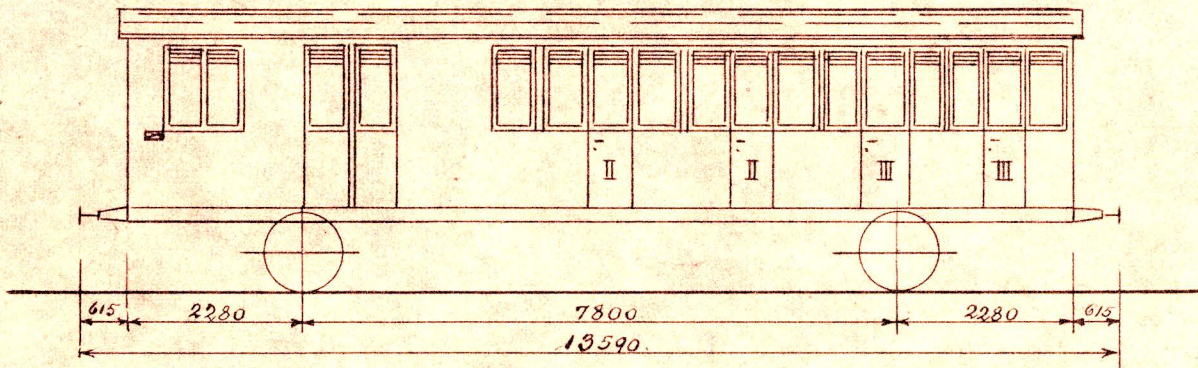

11 Elektr. Sys.

D.c. 126-128. 125.

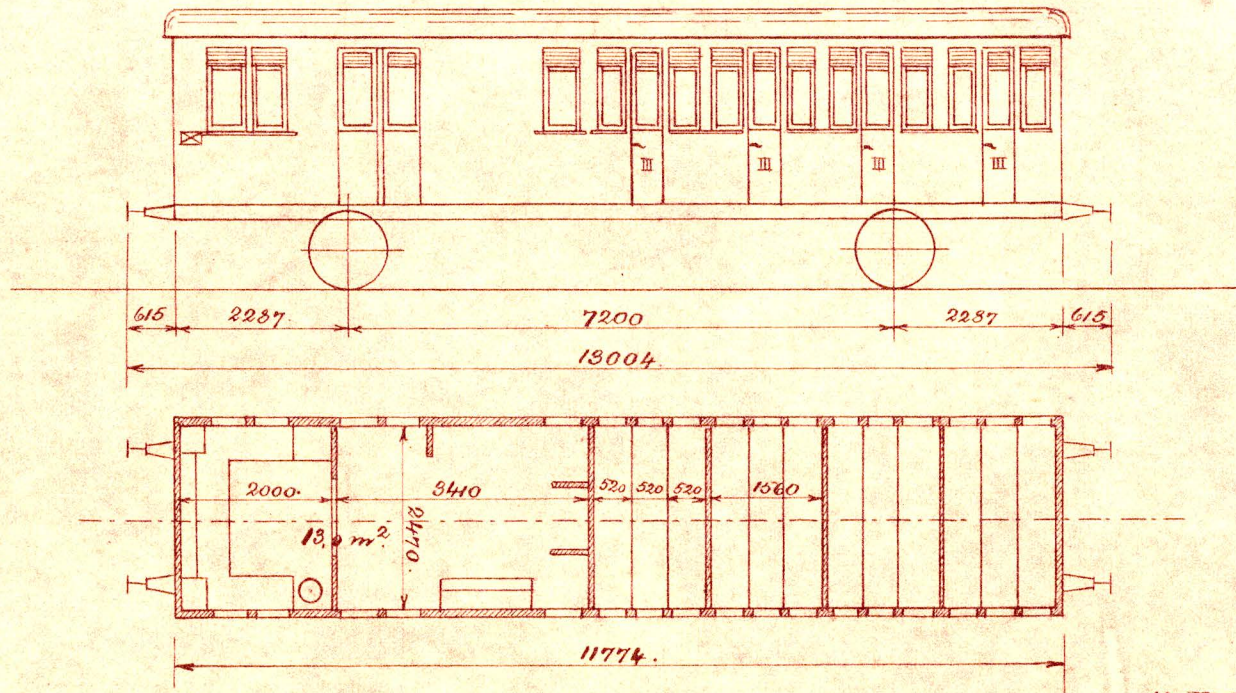

12 El. Lys.

D. 143-145.

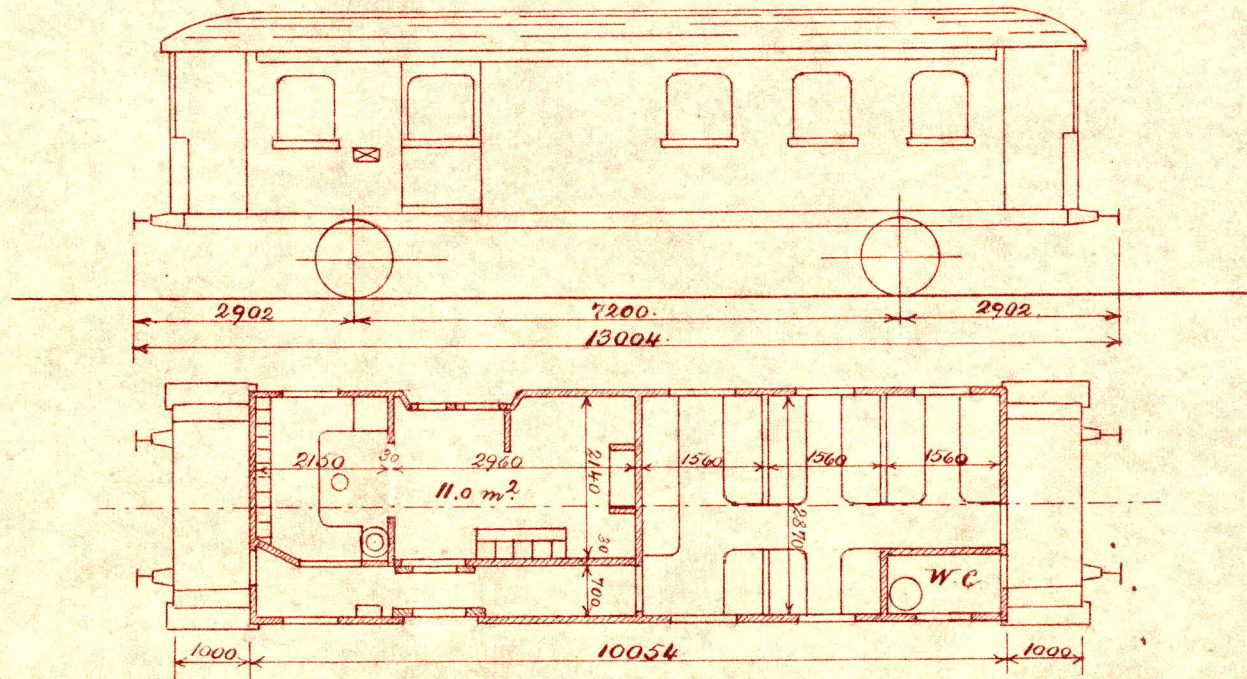

12 El Lys.  
Petroleum.

Q. 201-205.

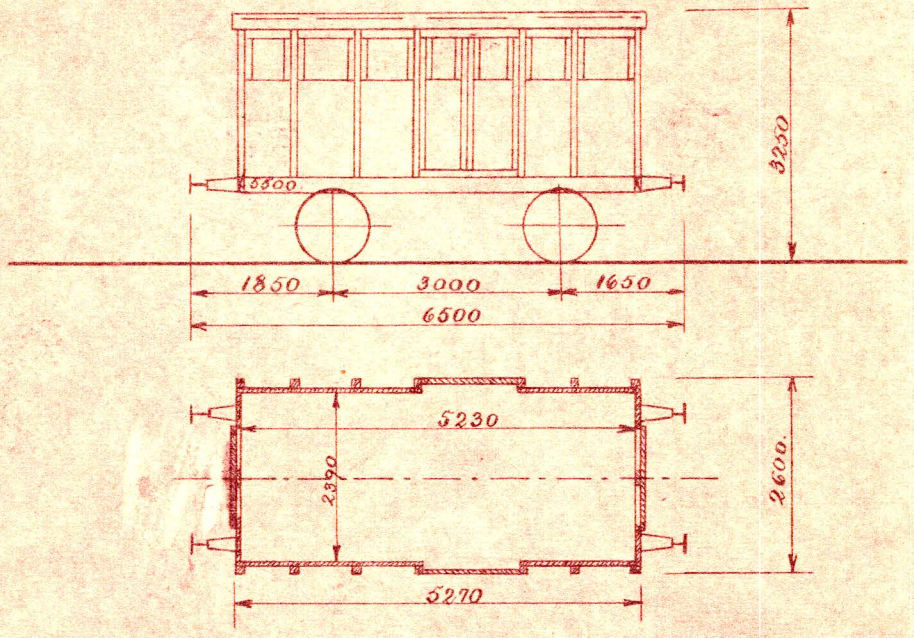

Q. 206-233.

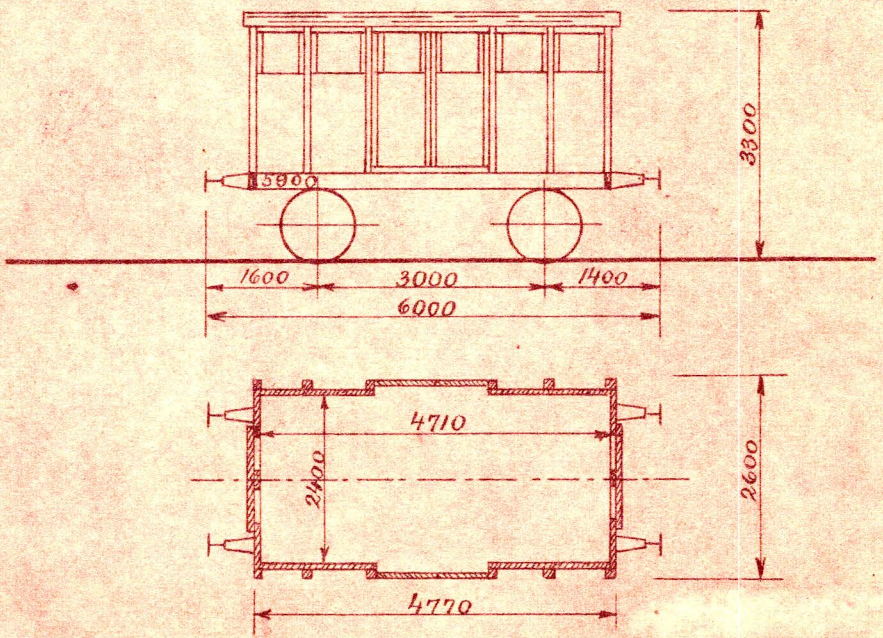

Q. 234-248

4334-4337

4340-4343

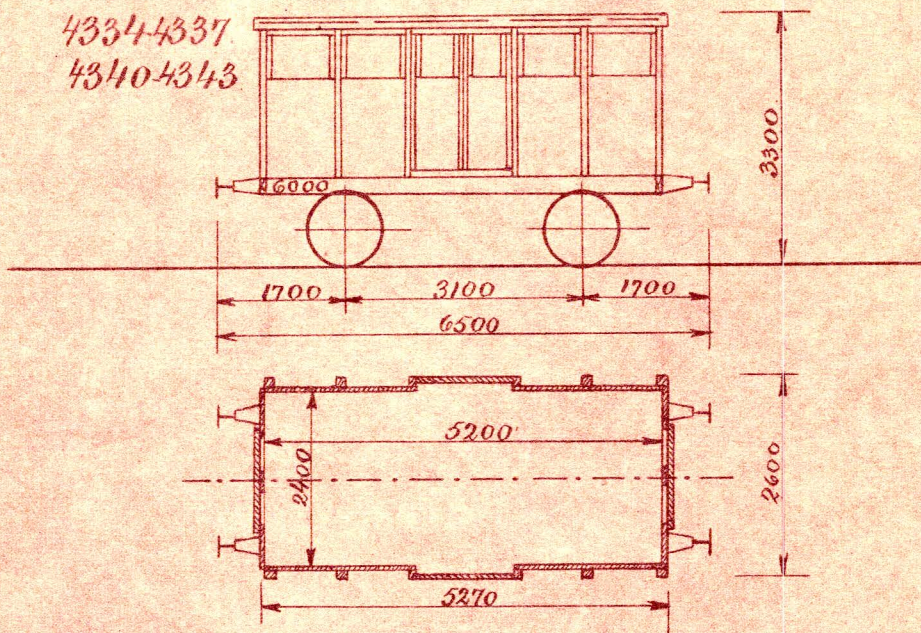

Q. 249-252

2314-2315

4344-4345

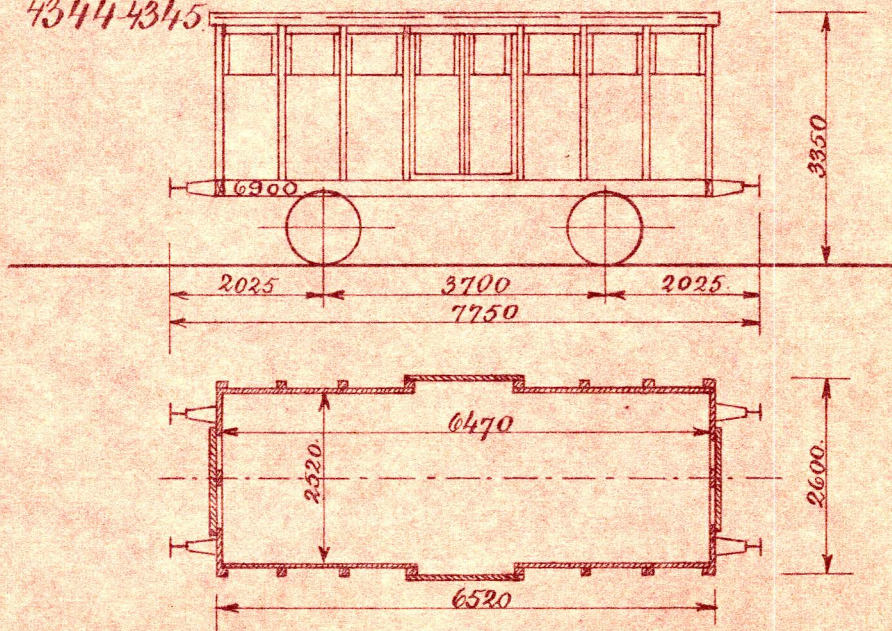

Q. 253-258.

2316

43464317.

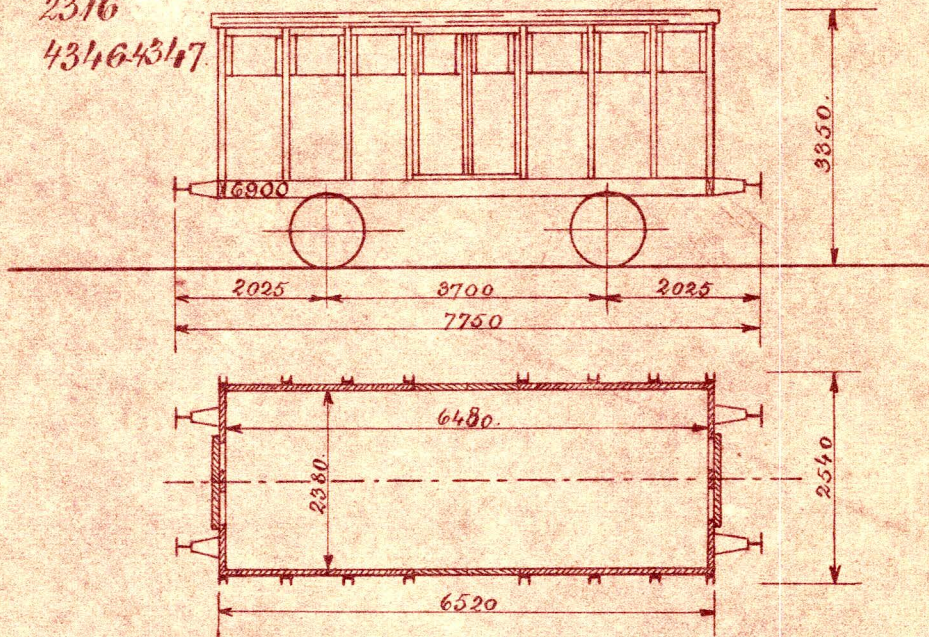

Q. 259-262, 263-331.

2318 2319, 2320-2334.

43484349,

4350-4362.

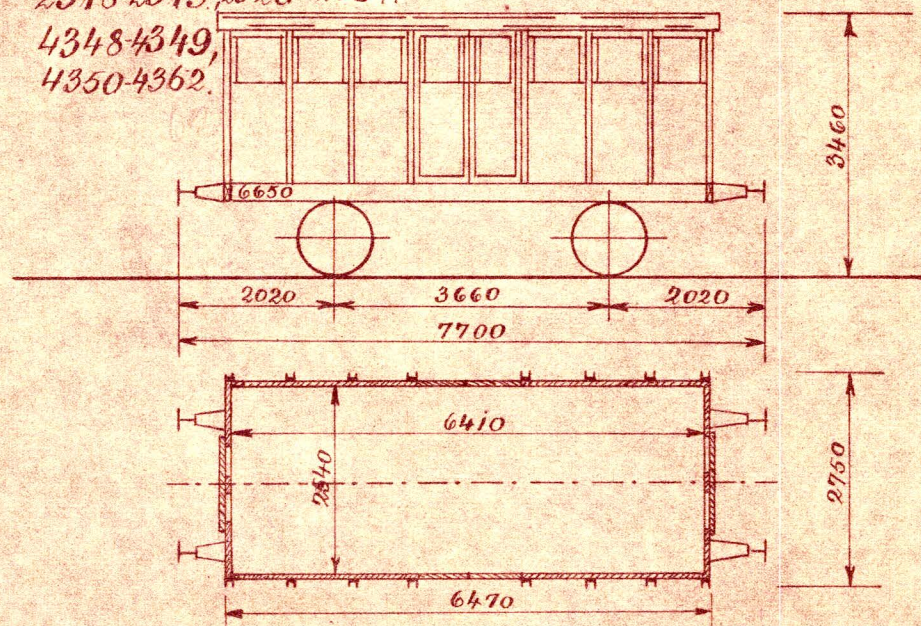

Q23012303.  
23102311.

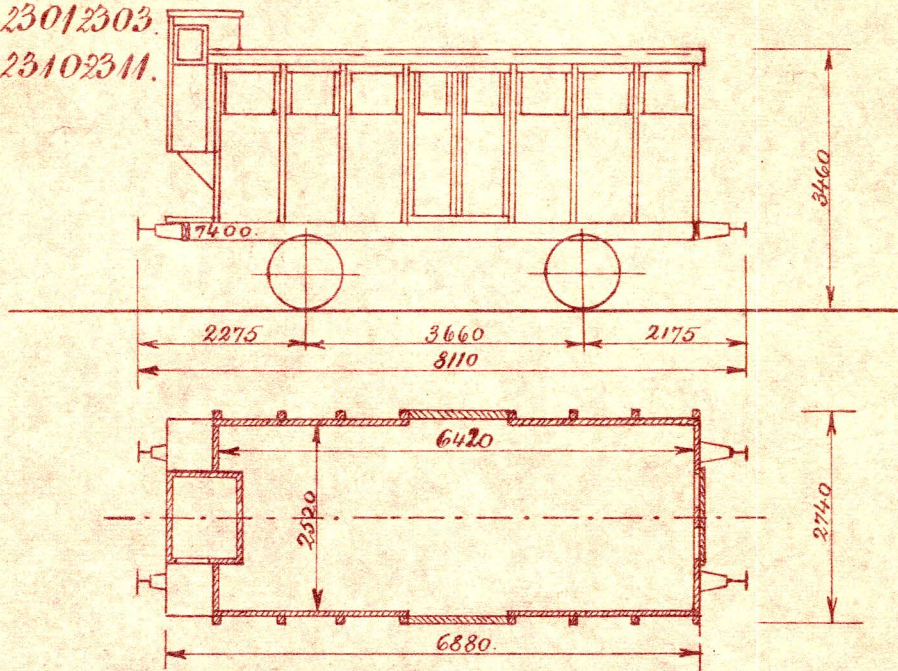

Q23042309.  
23122313.

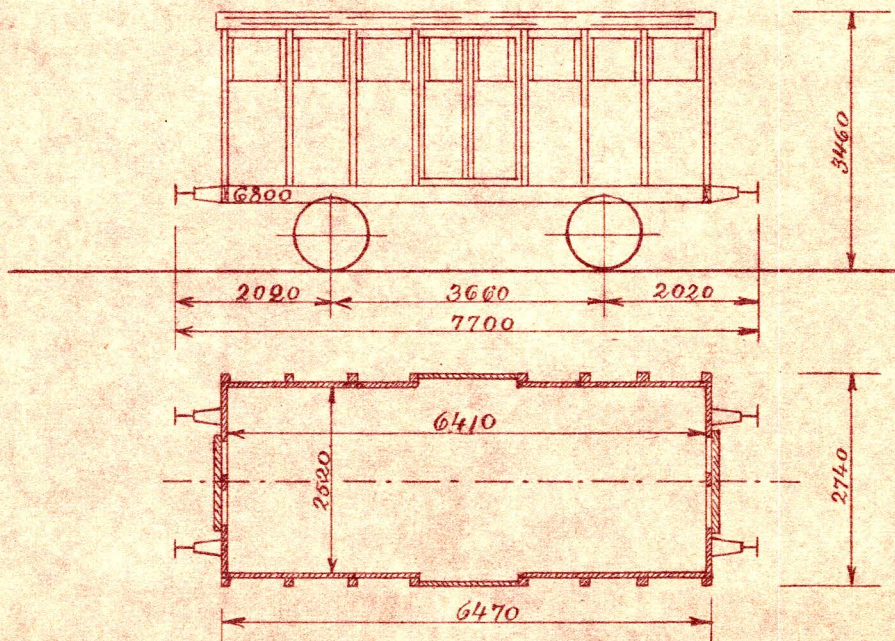



Q4331-4333.

4338-4339.

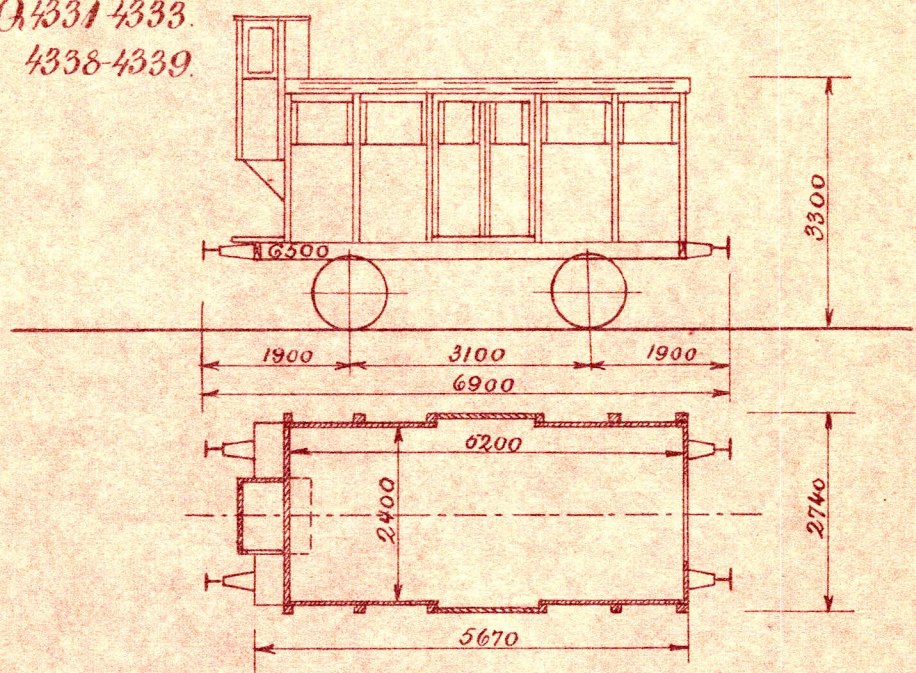

H. 400-413.

2421-4427.

4431-4437.

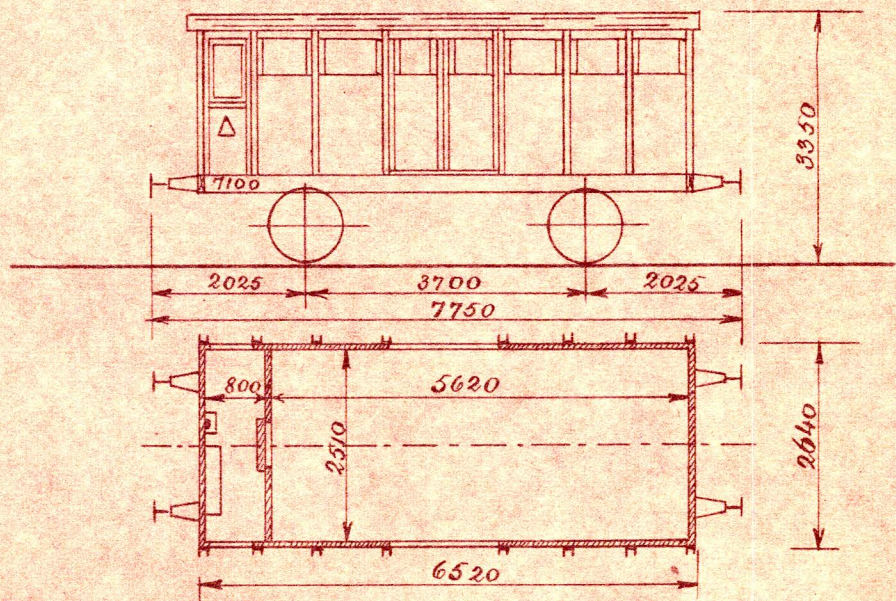

412, 413, 423 og 433 have høje sidetomme.

H. 414-419.

42

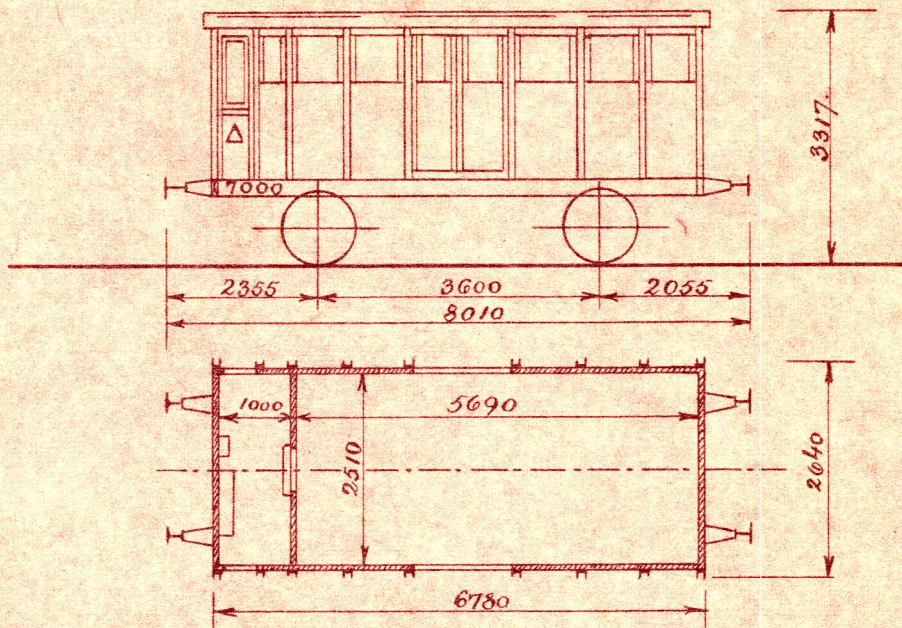

Q. s. 441-446.

43

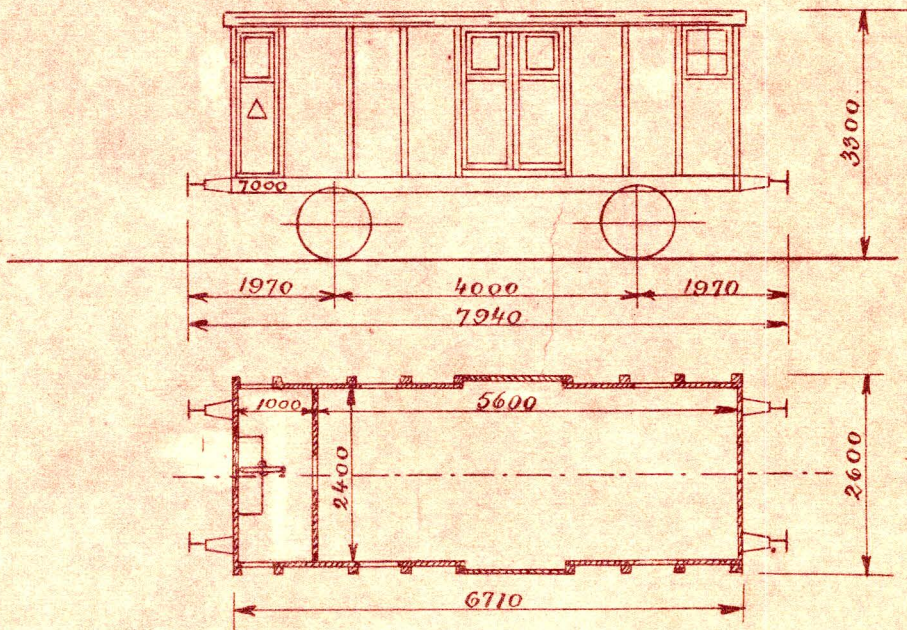

Q.s/461464.

44

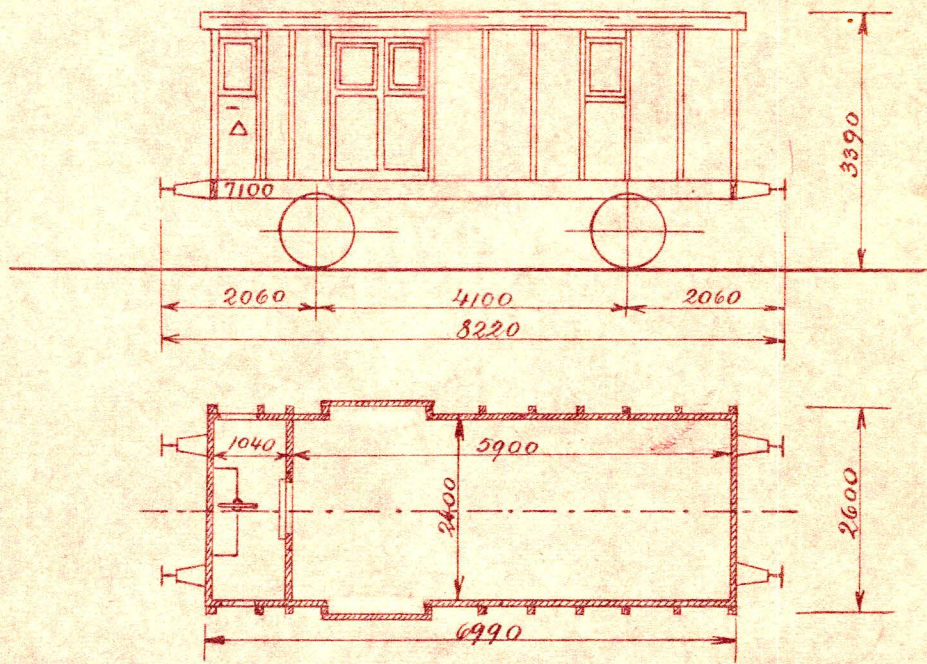

K. 501-504.  
2531-2532.

45

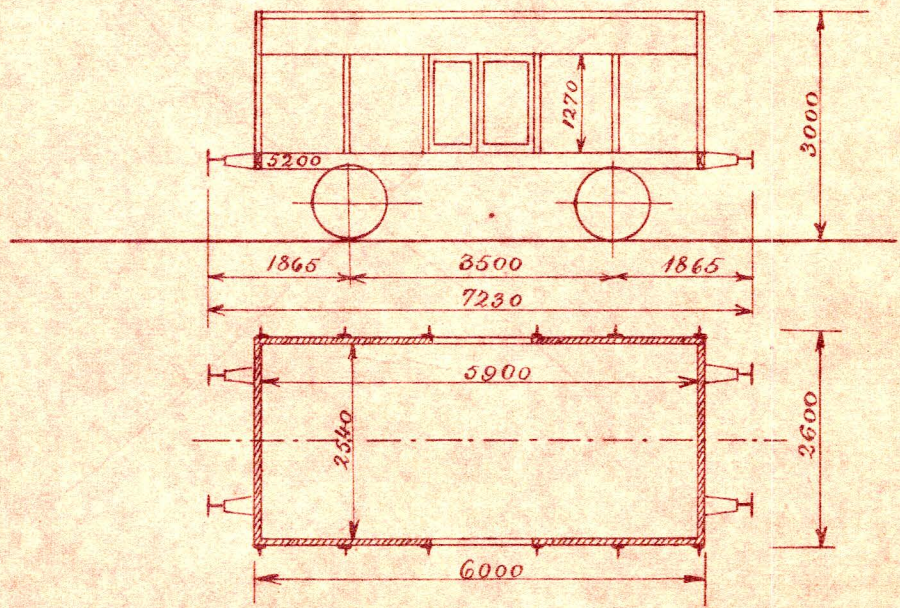

Kla. 504  
Kl. 506-512

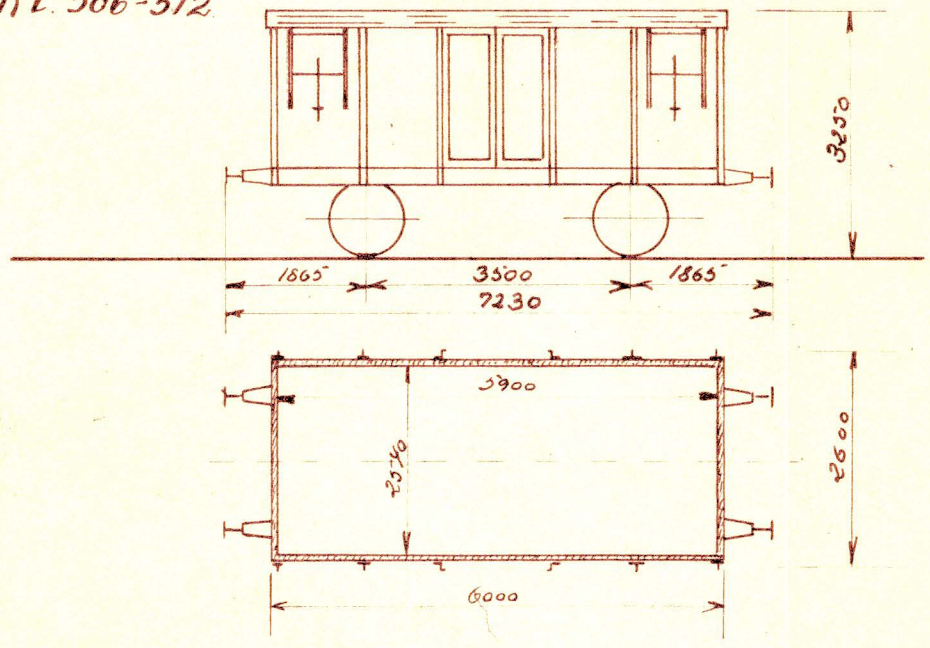

K. 505-512.

2533 2534

4541 4544.

46.

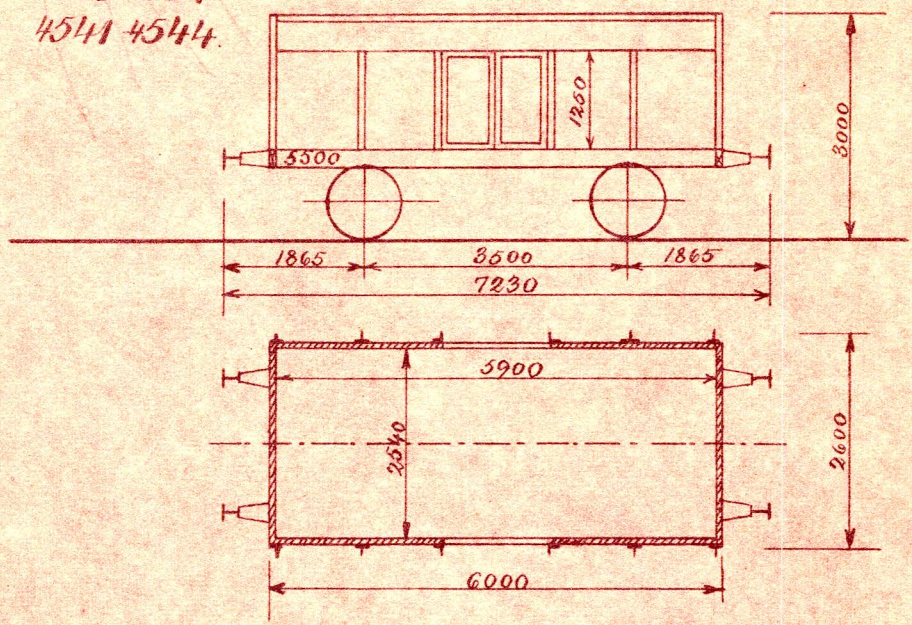

P. 601-602.

47.

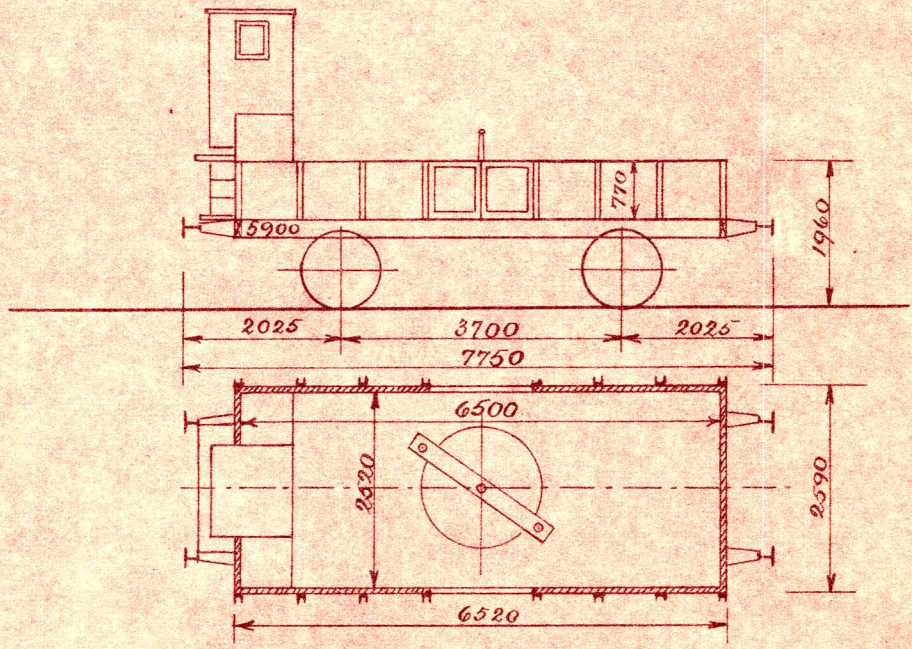

P. 603-612.

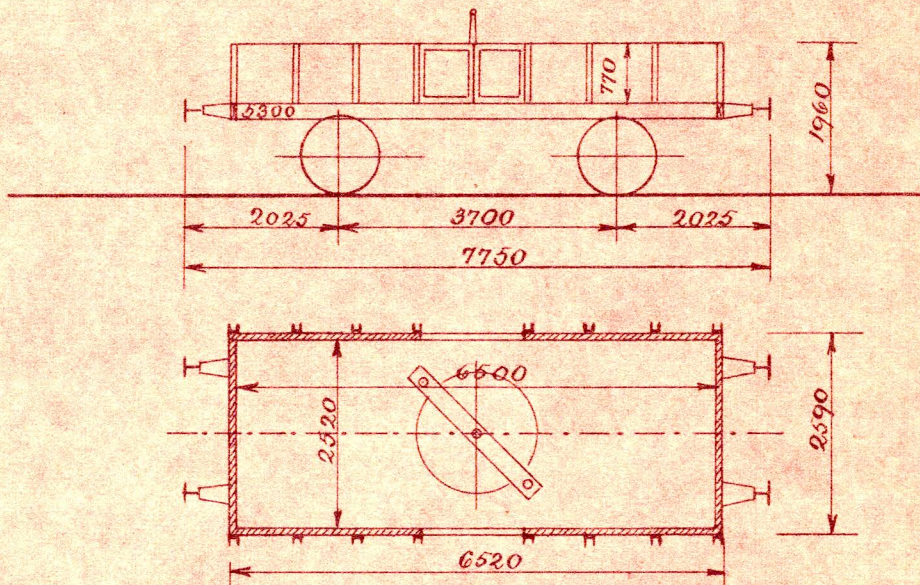

P. 616-623.

4701-4705

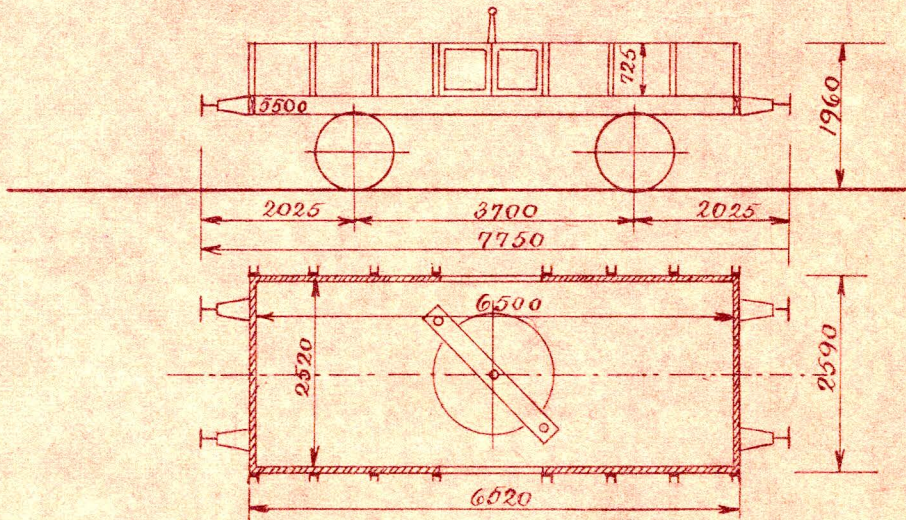

P2671-2672.

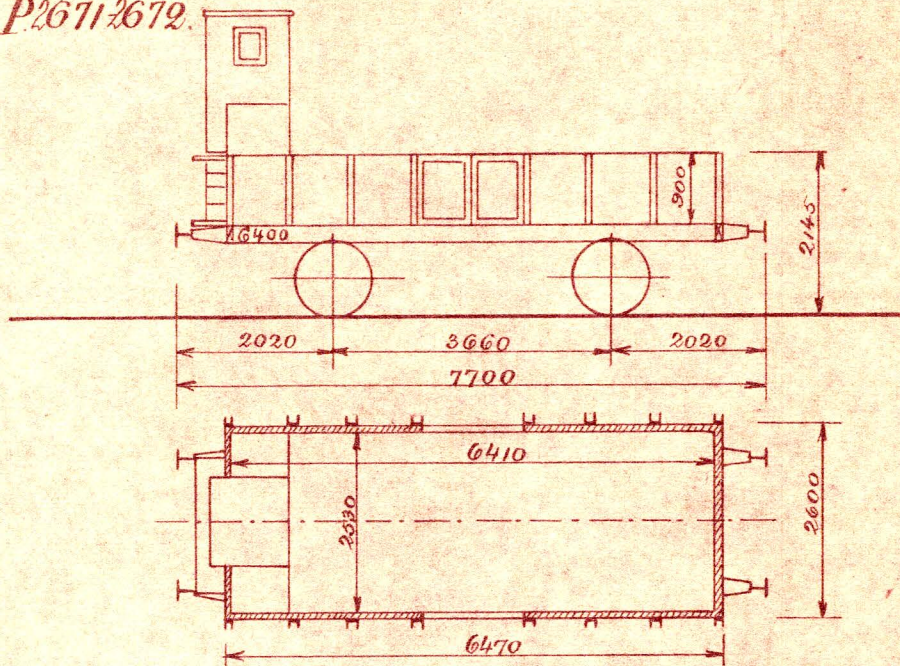

P2673-2678.

51.

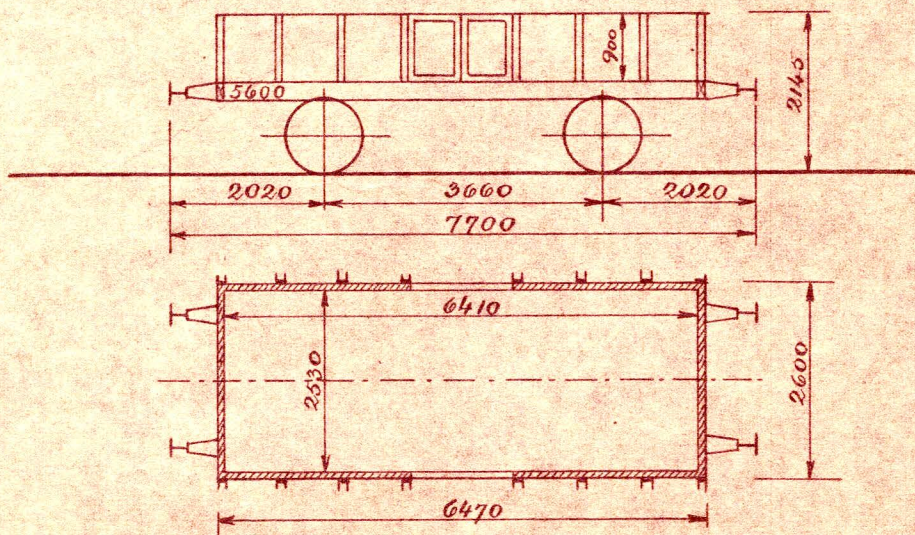

Pb. 771.

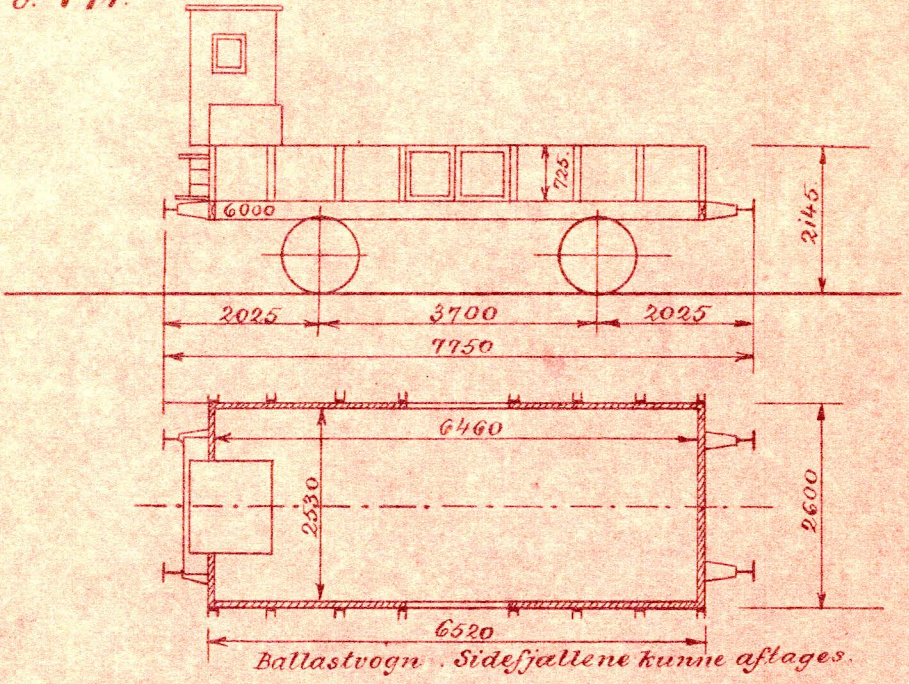

Pb. 772-780.

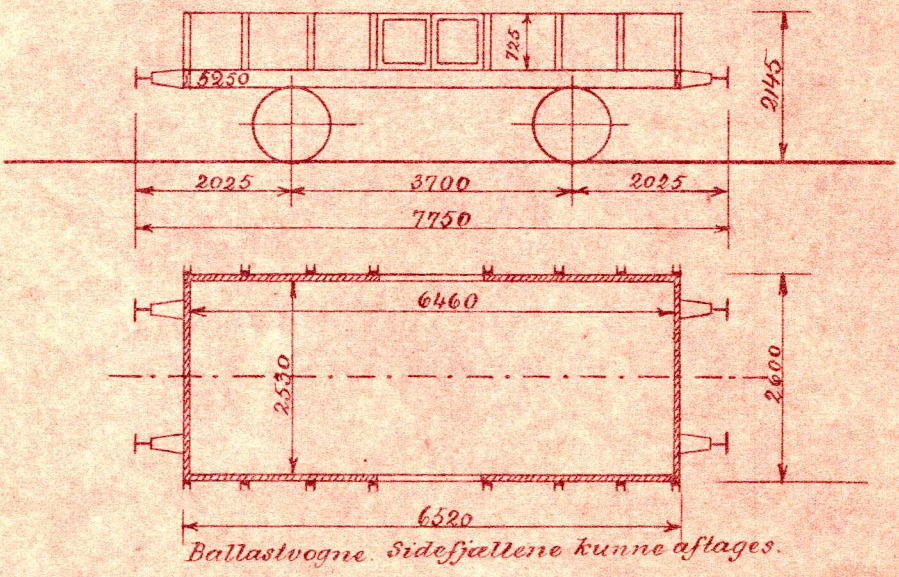



Pl 801-824. 826.

4861-4865.

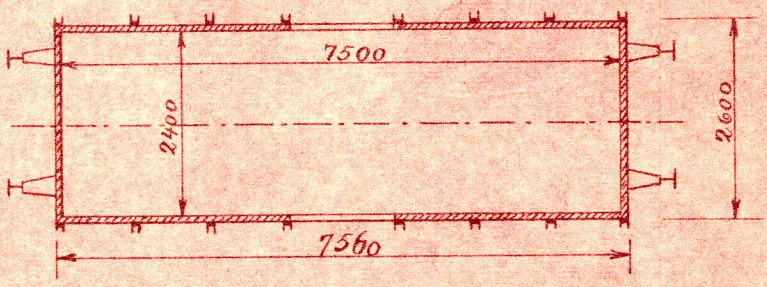
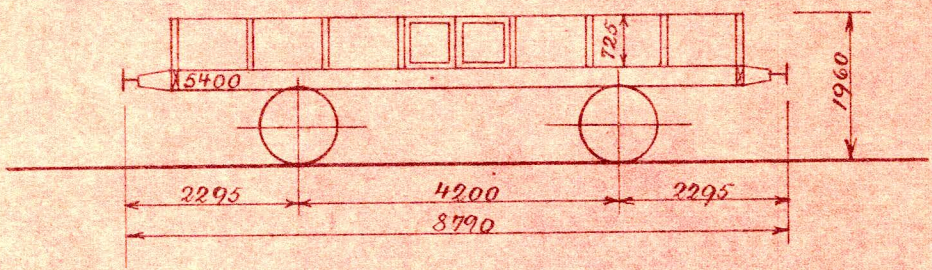

Pl 825-843.

4872.

2891.

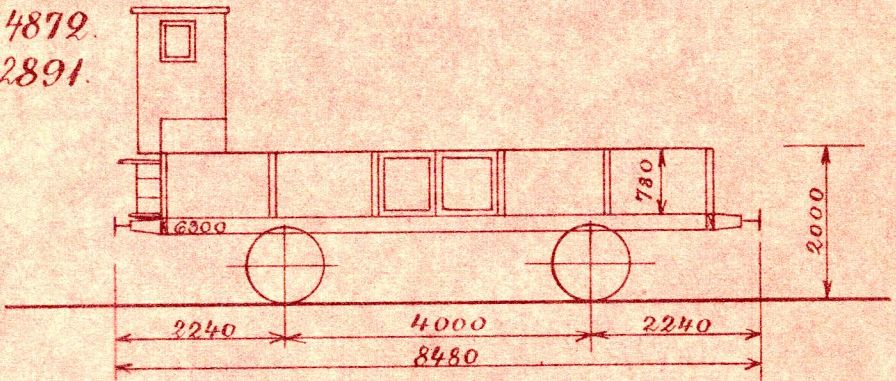

P<sub>3</sub> 1301-1310.

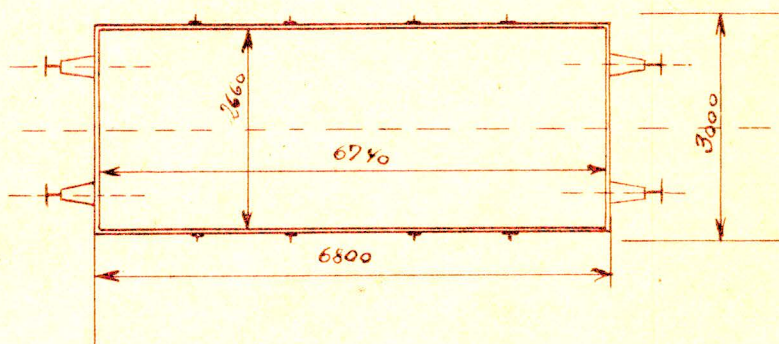
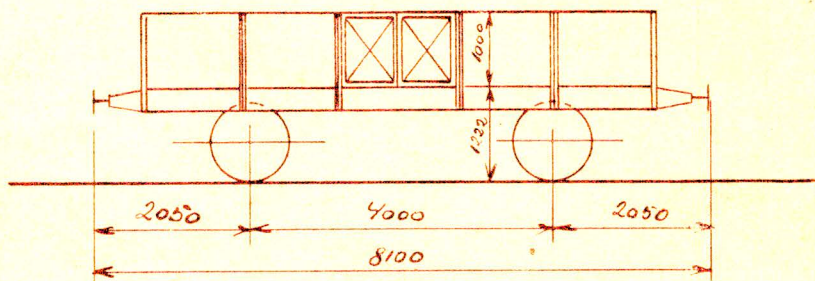

Pl. 850-853. и 856-859, 860, 951-997.

4877-4878. 4879-4881, 4883-4890, 4921-4925.

2895-2896. 2898-2899, 2900-2917

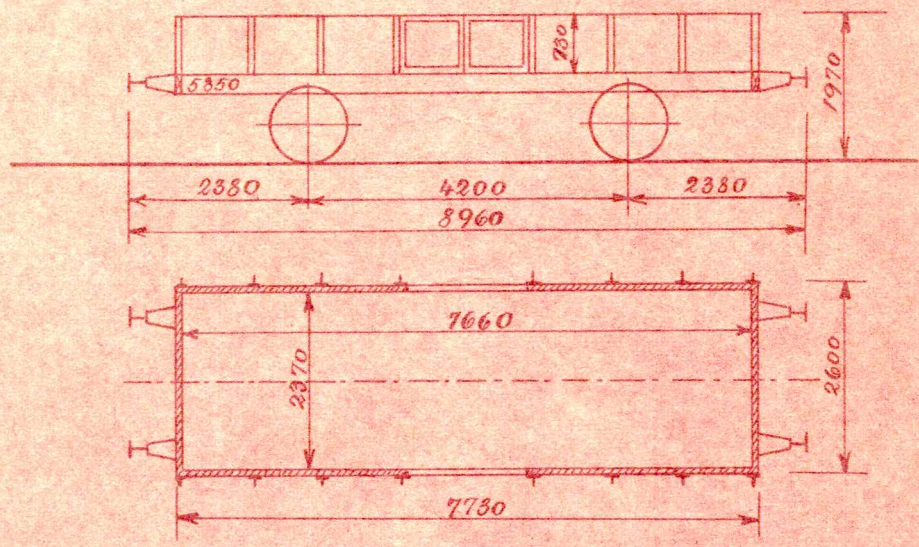

T3001-3004.

1009-1015.

5005-5007.

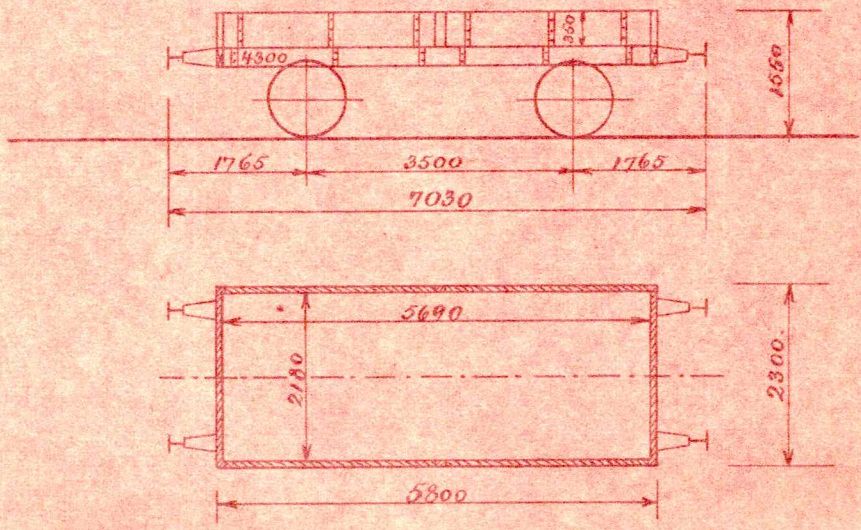

T. 5008.  
1016.

60.

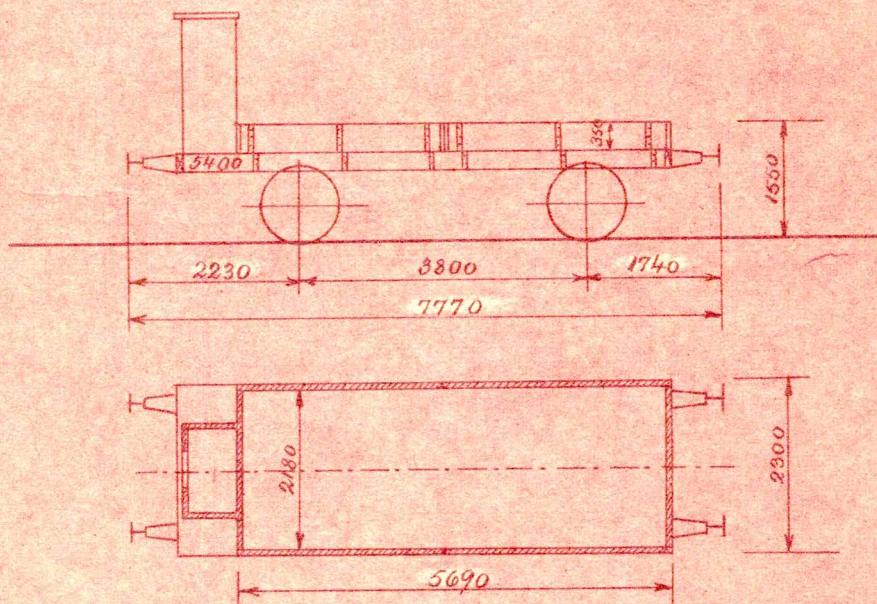

T. 3017-3022.

61.

