

ang. placering se tegn. 308L-24.310  
 Pos. 1-15 og pos. 18 udføres m. 3<sup>φ</sup> huller for pos. 17.  
 alle skilte udføres med sorte bogstaver på hvid bund.

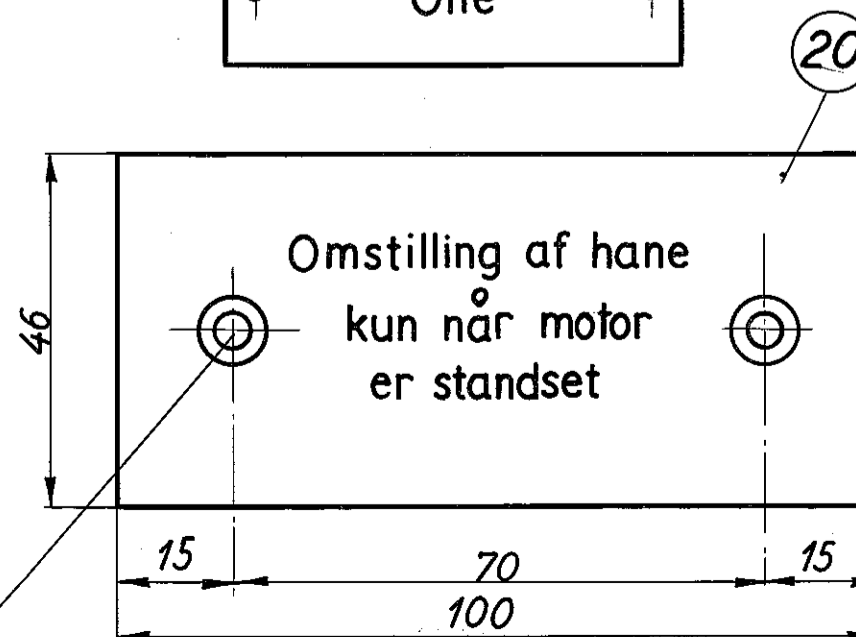

1	skilt	100 x 46	20	astralon	magasin		
			19				
1	skilt	60 x 20	18	astralon	magasin		
48	drivnitte	nr. 2 x 1/4"	17		magasin		
			16				
1	skilt	60 x 20	15	astralon	magasin		
1	skilt	60 x 20	14	astralon	magasin		
1	skilt	60 x 20	13	astralon	magasin		
1	skilt	60 x 20	12	astralon	magasin		
1	skilt	60 x 20	11	astralon	magasin		
1	skilt	60 x 20	10	astralon	magasin		
1	skilt	60 x 20	9	astralon	magasin		
1	skilt	60 x 20	8	astralon	magasin		
1	skilt	60 x 20	7	astralon	magasin		
3	skilt	60 x 20	6	astralon	magasin		
3	skilt	60 x 20	5	astralon	magasin		
1	skilt	60 x 20	4	astralon	magasin		
1	skilt	60 x 20	3	astralon	magasin		
2	skilt	150 x 80	2	astralon	magasin		
1	skilt	150 x 80	1	astralon	magasin		

Stk.	Betegnelse	Pos.	Materiale kvalitet	Model nr. eller materiale størrelse	rå vægt	færdig vægt
Tegn. <b>BHH</b> Rev. <b>E.N.</b> Af. <b>LL</b> Målestok: <b>1:1</b> Kalk. <b>AB 1-10-57</b> Norm. Date <b>27-9-57</b> Dato Retelse Indeks						
				<b>FRICHS</b>		
Anvendelse				Stykliste nr.		
<b>Diesel-mek. 167/183 hk. rangertr.</b>				<b>21139</b>		
Tegningens benævnelse				Tegningens nummer		
<b>Skilte til førerbord</b>				<b>308L-24.311</b>		
Indeks:						

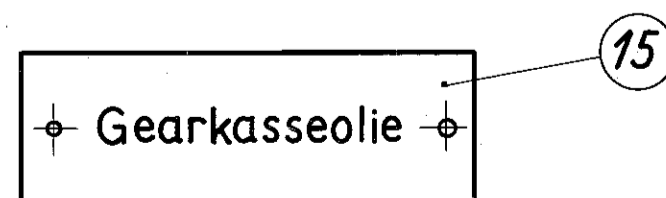
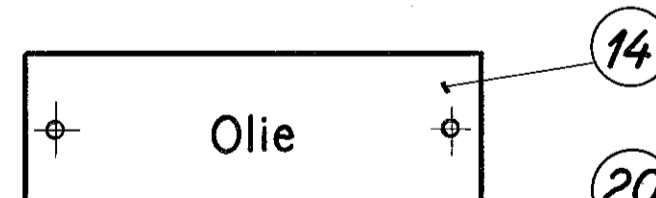
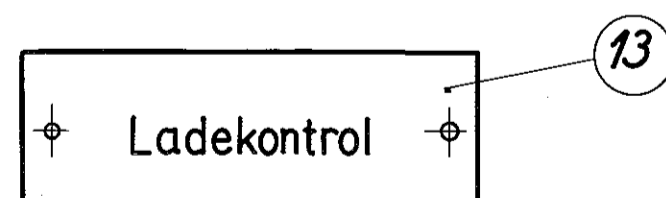
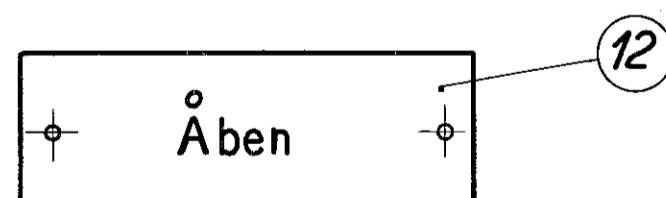
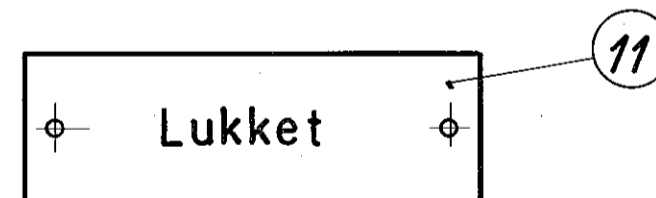
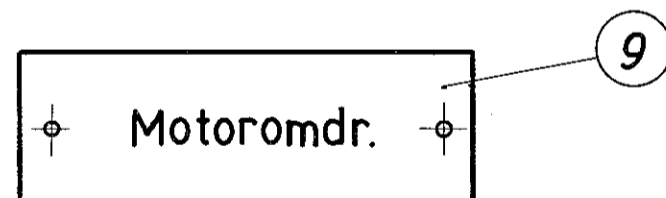
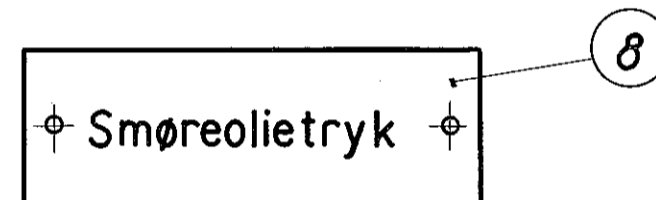
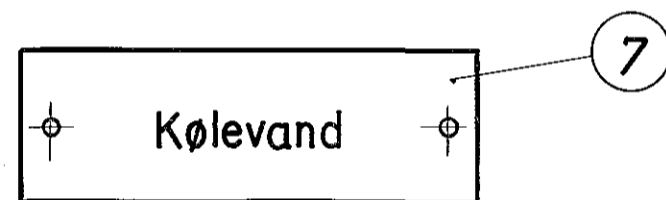
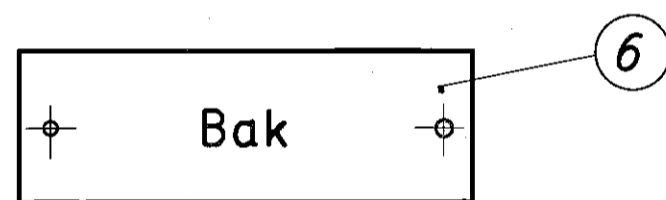
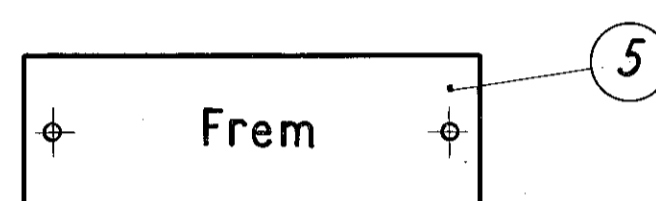
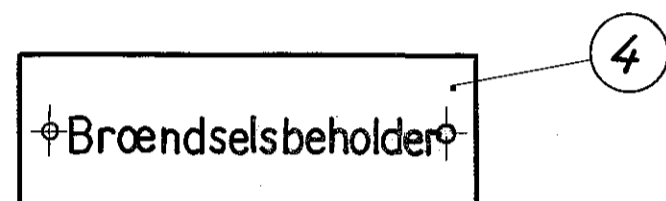
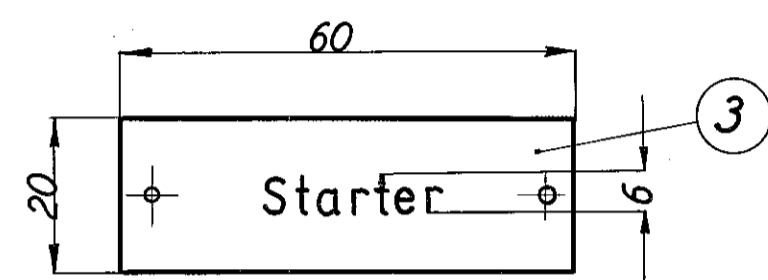