

Venstre Rammeplade set indvendig fra.

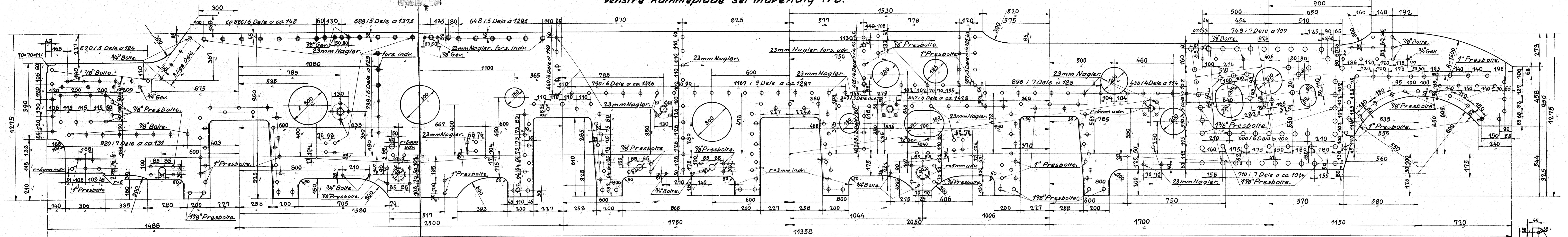

Rammepladens Tykkelse 25mm.

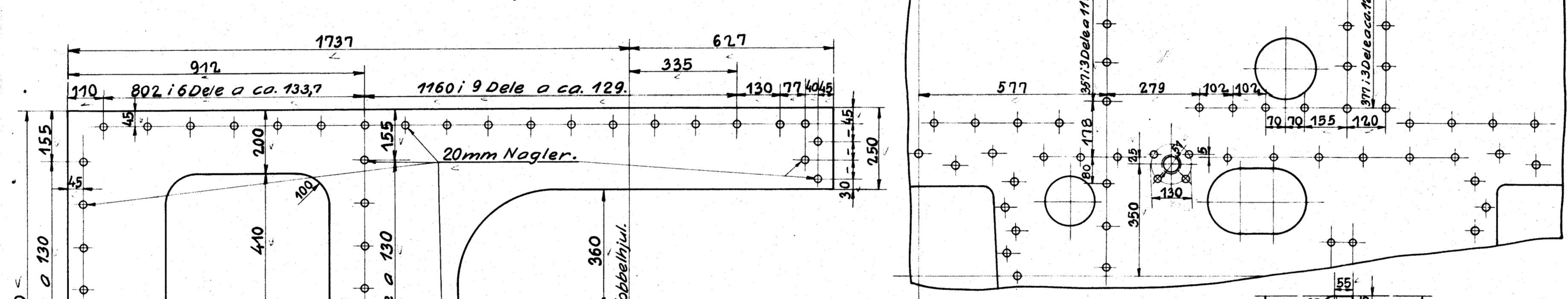

Højre Rammeplade set udvendig fra.

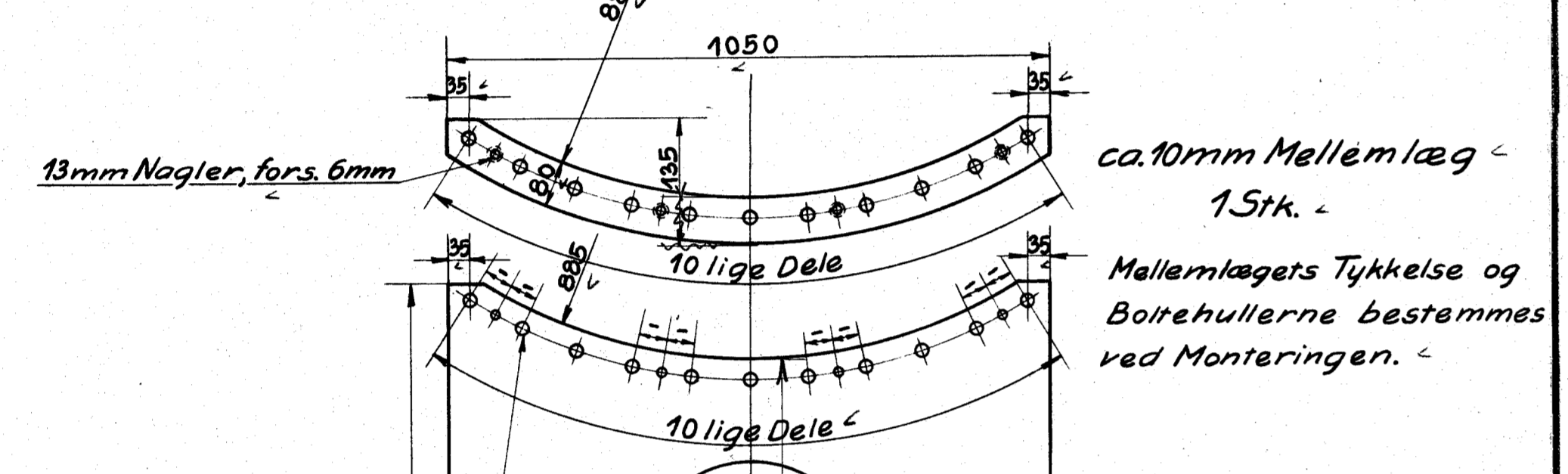
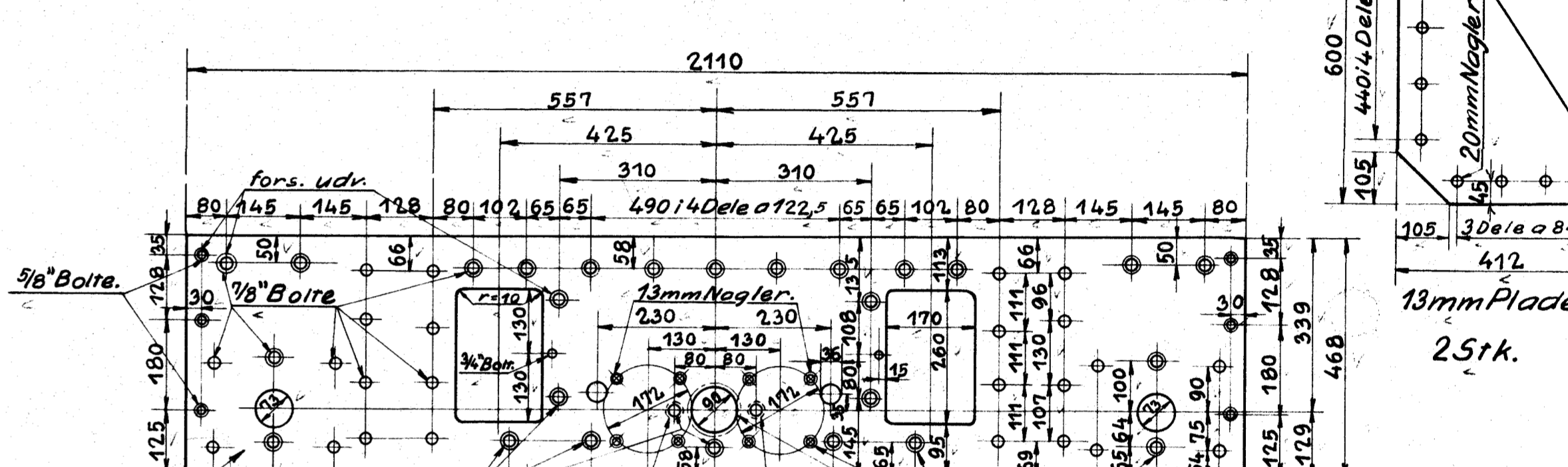

30mm Jernplade 15stk.

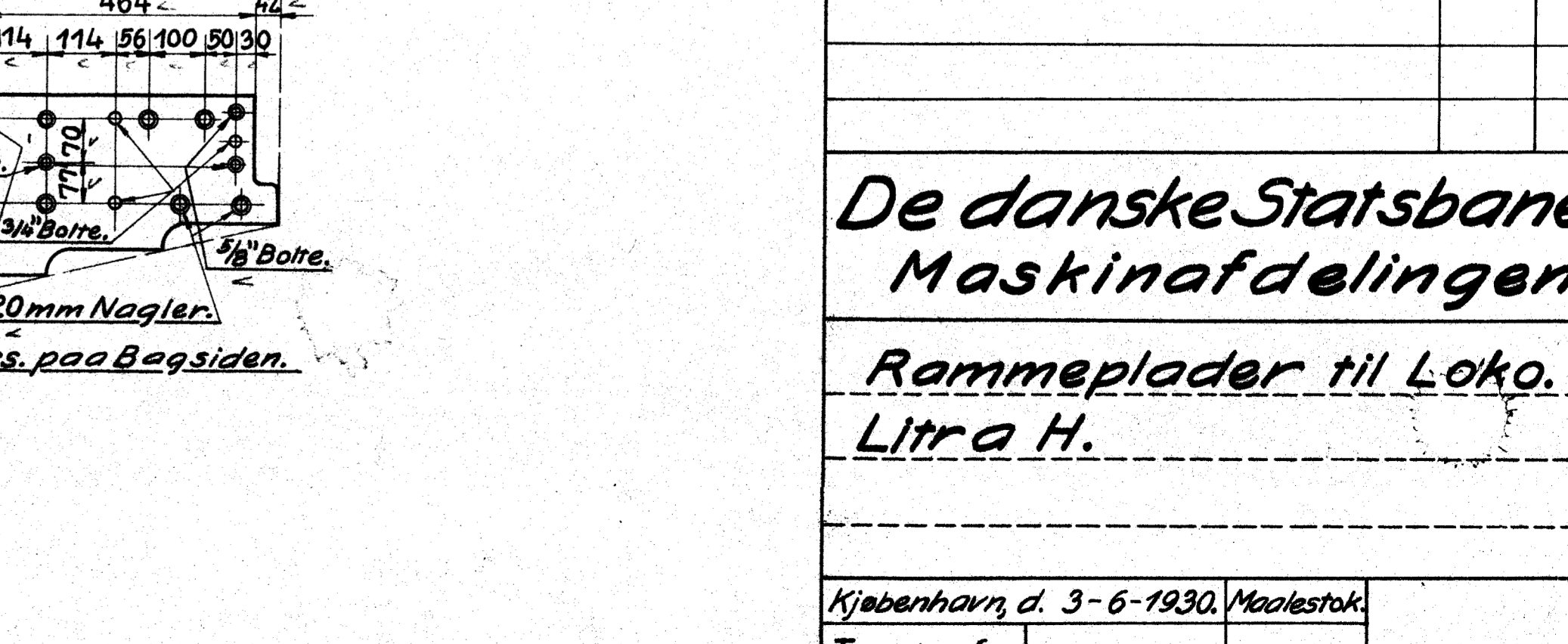
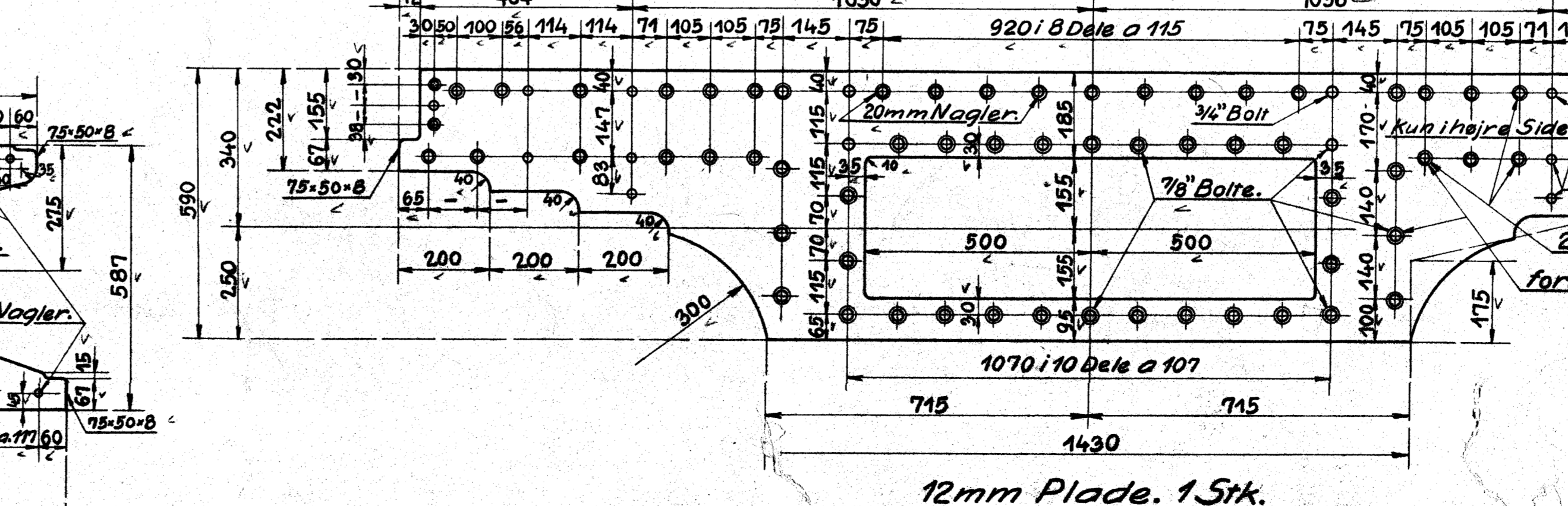
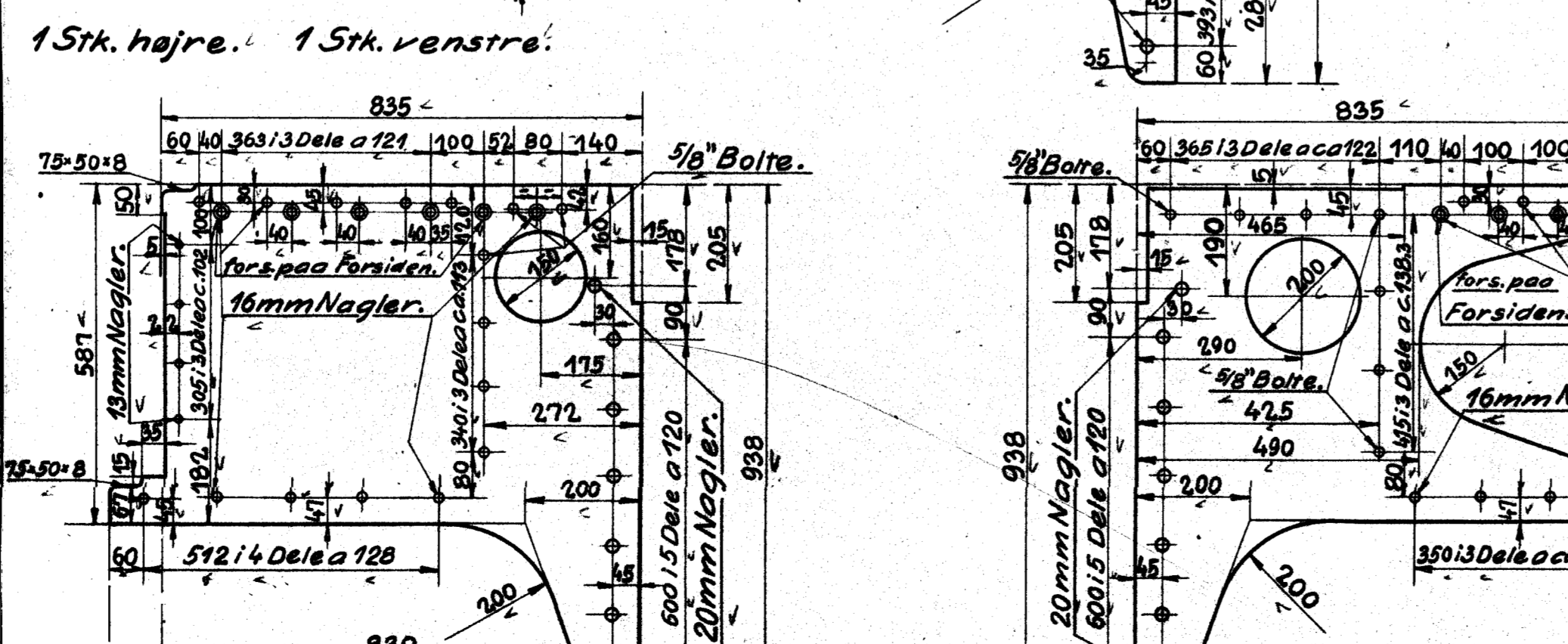
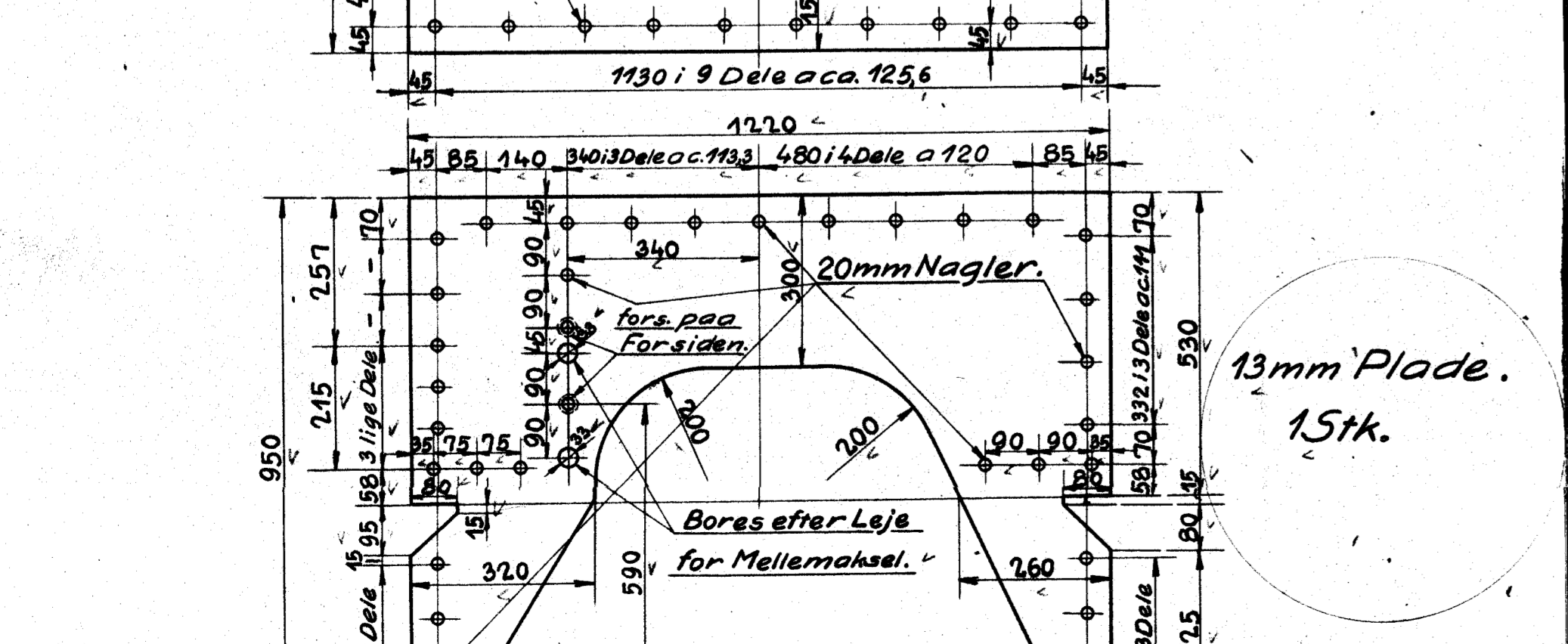
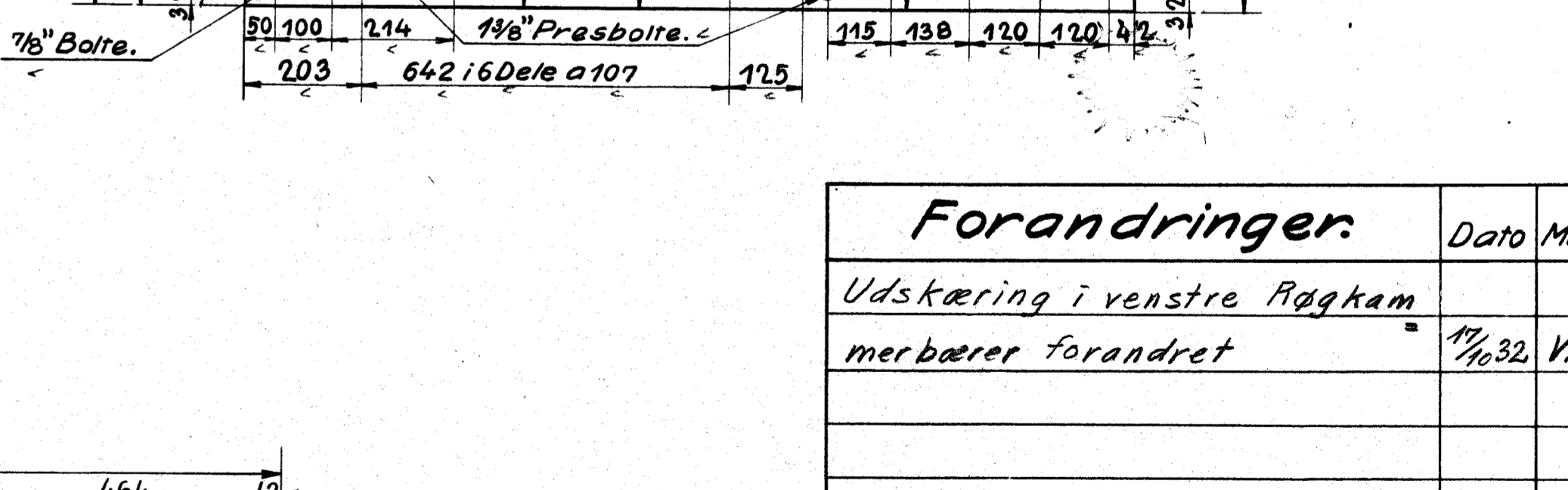
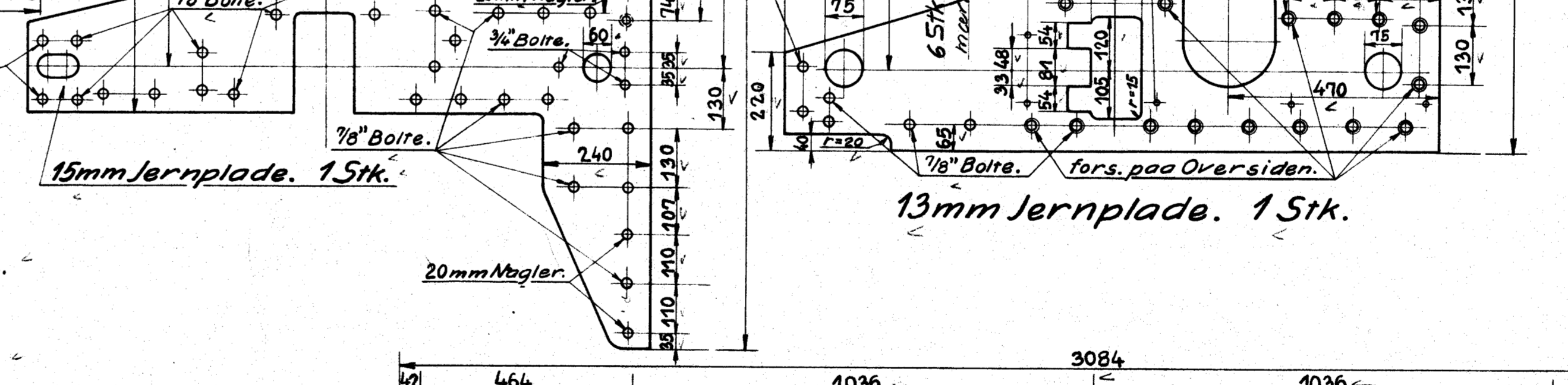
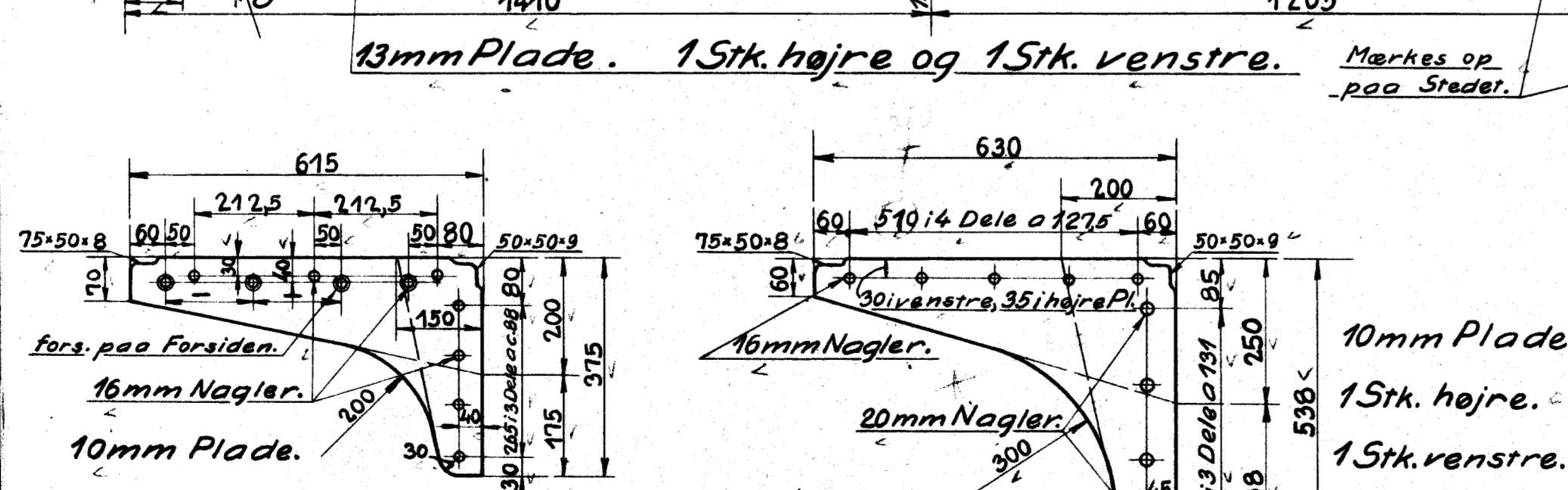
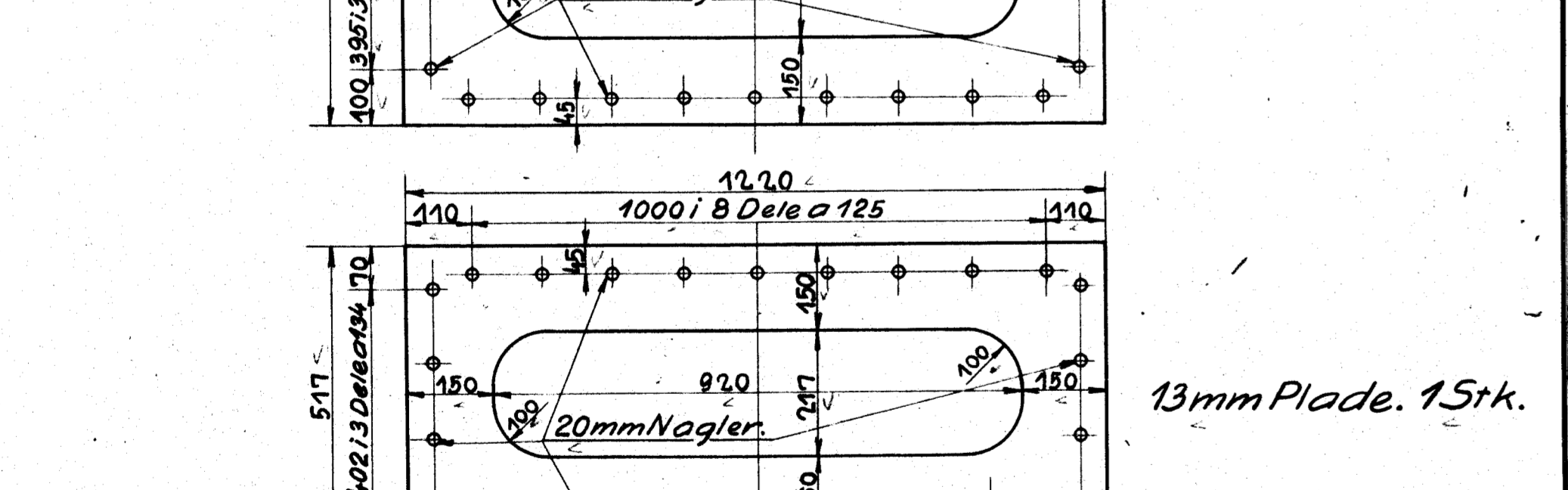
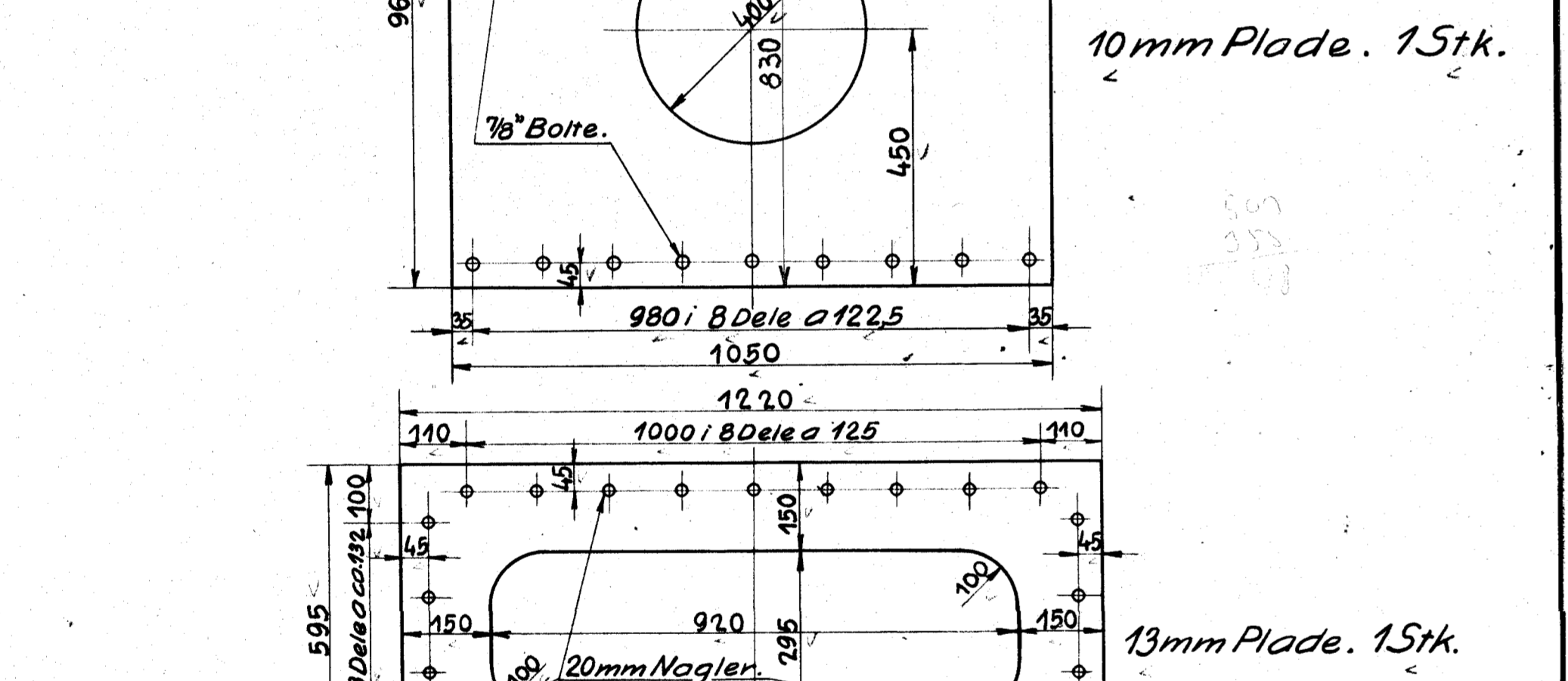
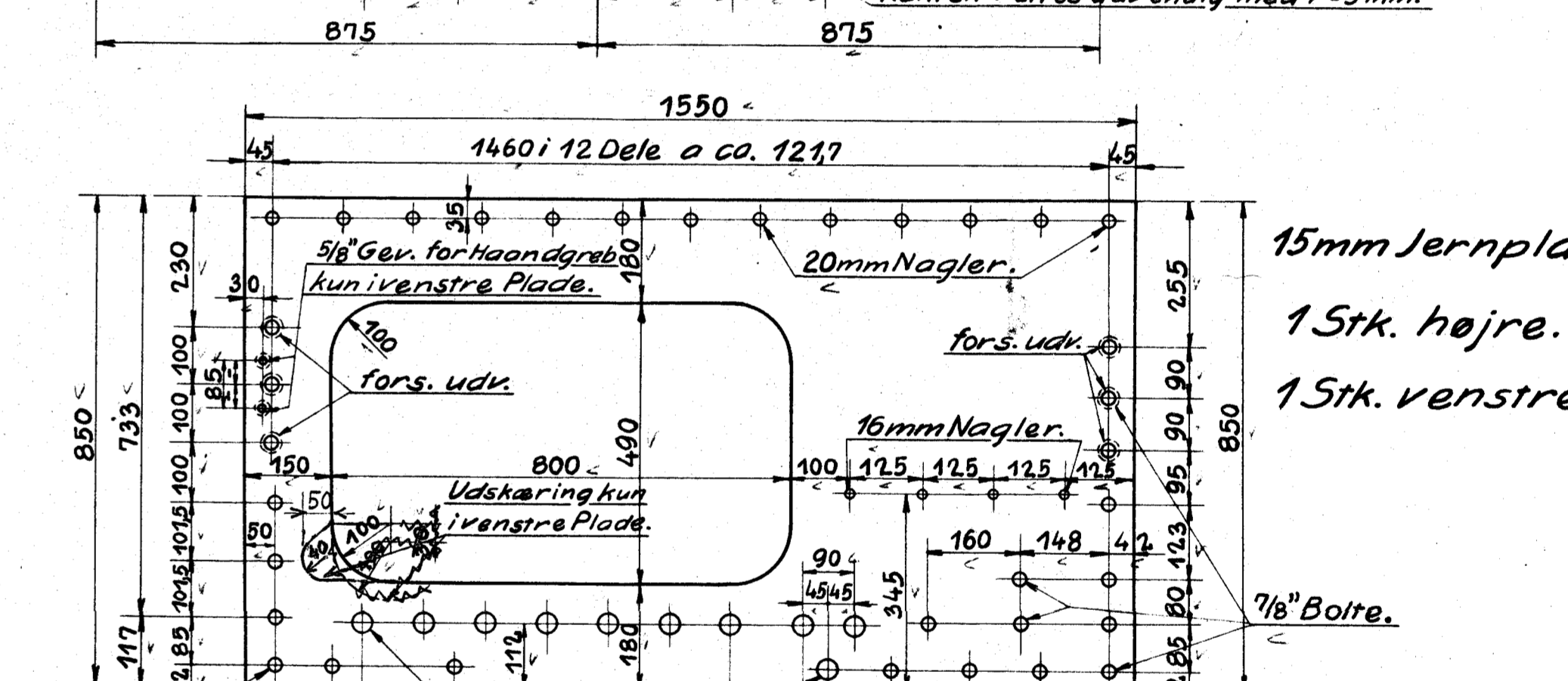
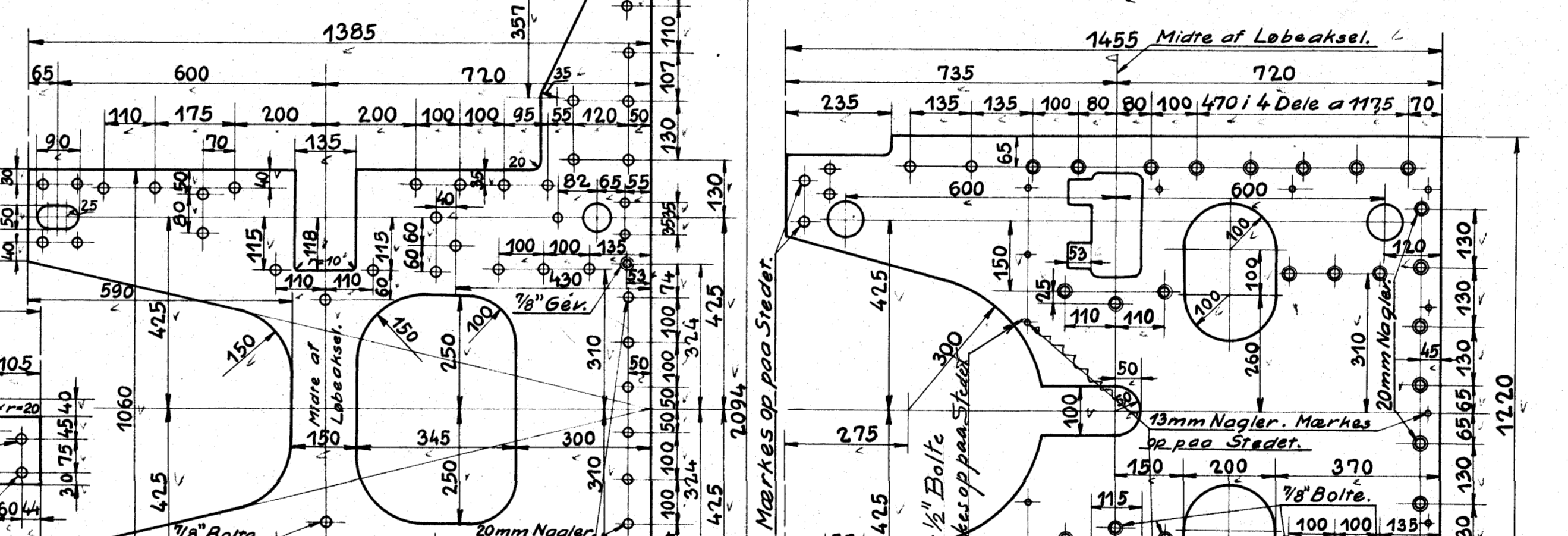

Forandringer	Dato	Merke
Udskæring i venstre Ragkam		
merberer forandret	1/6 32	V.S.

De danske Statsbaner.
Maskinafdelingen.
Rammeplader til Loko.
Litra H.

Kjøbenhavn, d. 3-6-1930. Maaletak.
Tegner af Kalkers et B. Nordmann.
Revideret af V. Thomsen.
1:10. H.686.

Arkiv 23/6-30

H.686.