

0.  
1.

LON.  
D.S.B.

Bagsiderist  
for Loko Ltr. S

3.200-52.

*Kun for nittet fyrkasse*

1945.

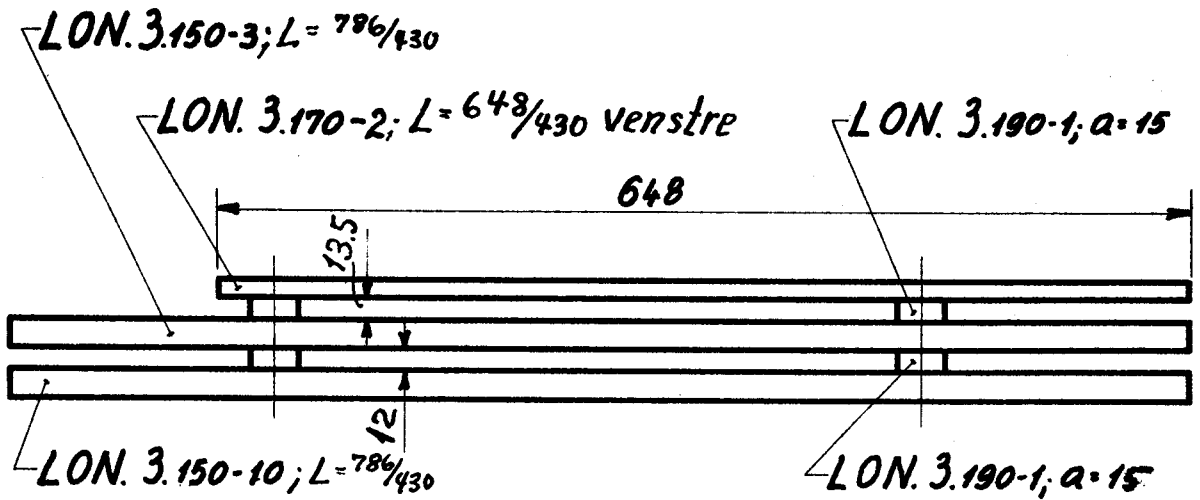
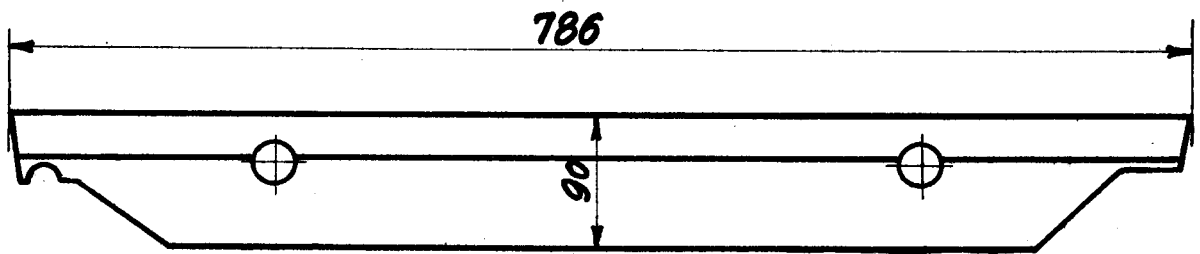

*venstre*

Rekvissionsbetegnelse	Materiale	Model Nr.	Mindstebeholdn	
Bagsiderist LON. 3.200-52	Flussjern.		Kh.	Ar.

3

0.  
1.LON.  
D.S.B.Bagsiderist  
for Loko L.tr.S

3.200-53.

*Kun for nittet fyrkasse*

1945.

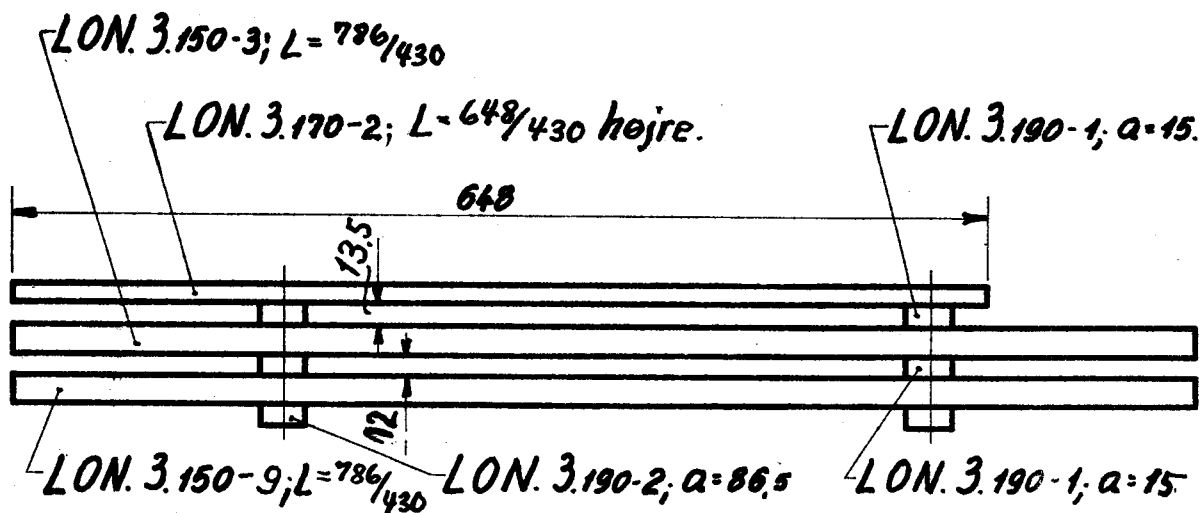
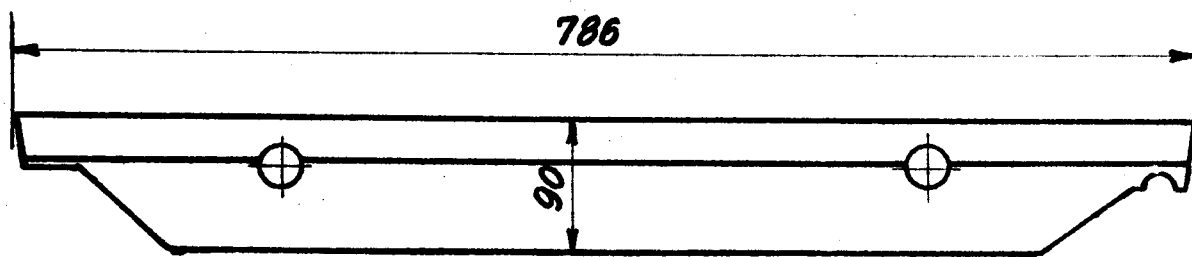
*højre*

Rekvistionsbetegnelse

Materiale

Model Nr.

Mindstebeholdn

Bagsiderist. LON. 3.200-53.

Flussjern.

Kh.

Ar.

4

0.  
1.

LON.  
D.S.B.

Mellemsiderist  
for Loko Ltr.S

3.200-54.

1945.

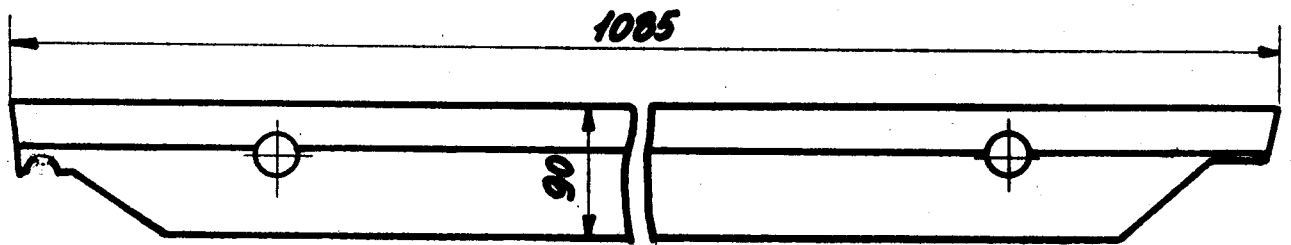

LON. 3.150-3; L = 1085/730

LON. 3.170-1; L = 1085/730 venstre

LON. 3.190-1;  $\alpha = 15$ .

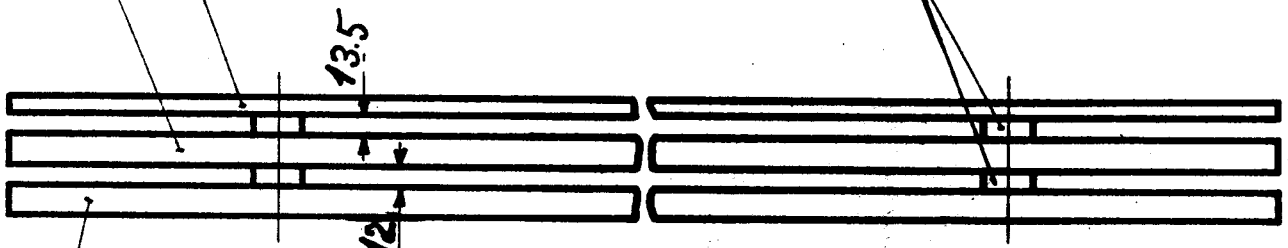

LON. 3.150-10; L = 1085/730

venstre

5

Rekvissionsbetegnelse	Materiale	Model Nr.	Mindstebeholdn.
Mellemsiderist LON. 3.200-54	Flussjern.		Kh. Ar.

0.  
1.

LON.  
D.S.B.

Mellemsiderist  
for Loko Ltr. S

3.200-55.

1945.

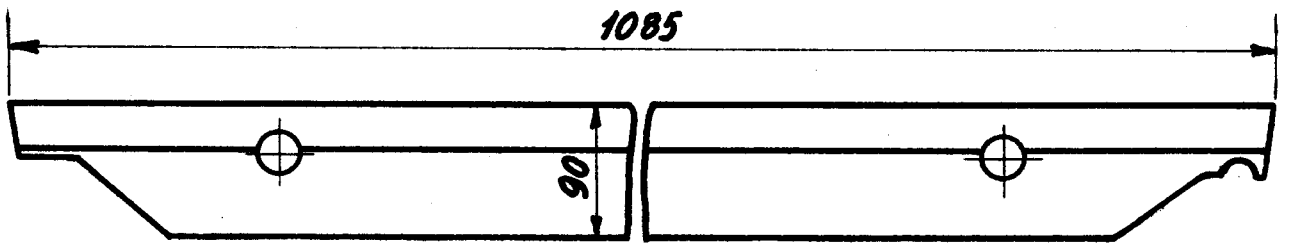

LON. 3.150-3; L = 1085/730

LON. 3.170-1; L = 1085/730 højre

LON. 3.190-1; a = 15.

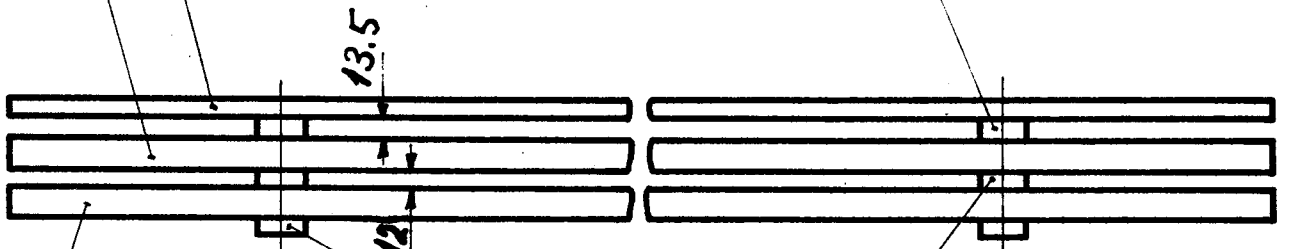

LON. 3.150-9;  
L = 1085/730

LON. 3.190-2; a = 88,5

LON. 3.190-1; a = 15.

højre

Rekvissionsbetegnelse	Materiale	Model Nr.	Mindstebeholdn.	
Mellemsiderist. LON. 3.200-55	Flussjern		Kh.	Ar.

6

0.

LON.  
D.S.B.Bagsiderist  
for loko. ltr. S.

3.200-56

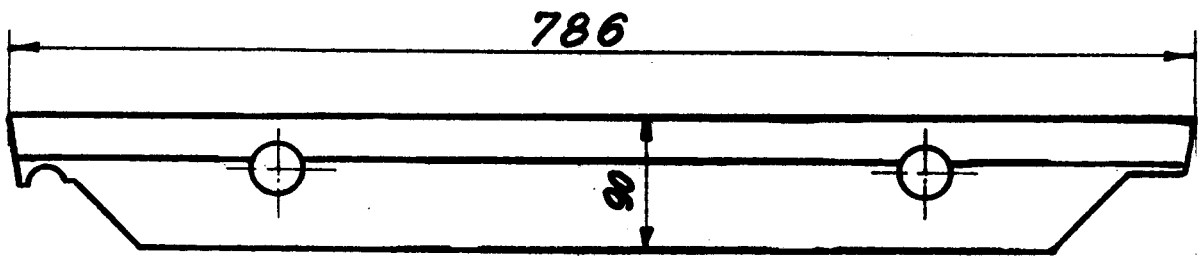
*Kun for svejst fyrkasse*

LON. 3.150-3; L = 786/430

LON. 3.170-1, L = 760/430 venstre

LON. 3.190-1; a = 15.

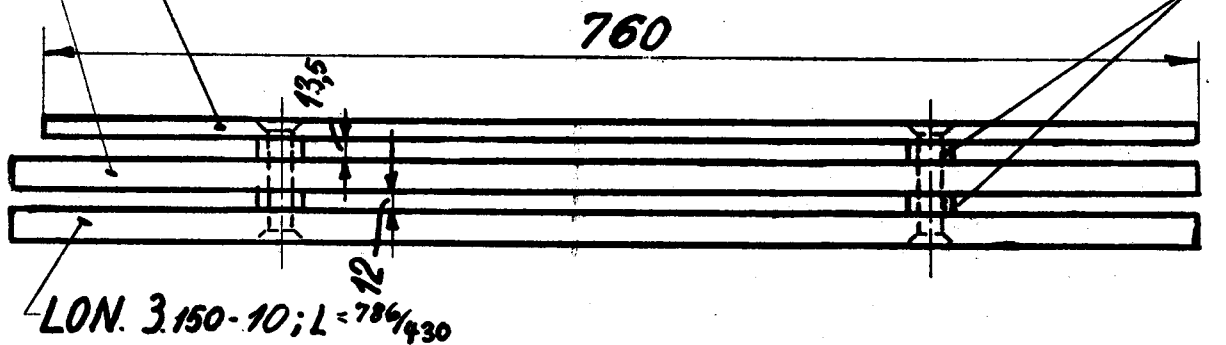
*venstre*

Rekvissionsbetegnelse	Materiale	Model Nr.	Mindstebeholdn.	
Bagsiderist. LON. 3200-56	Flussjern.		Kh.	Ar.

1

0.

LON.  
D.S.B.Bagsiderist  
for loko. ltr. S.

3.200-57

*Kun for svejst fyrkasse*

1943

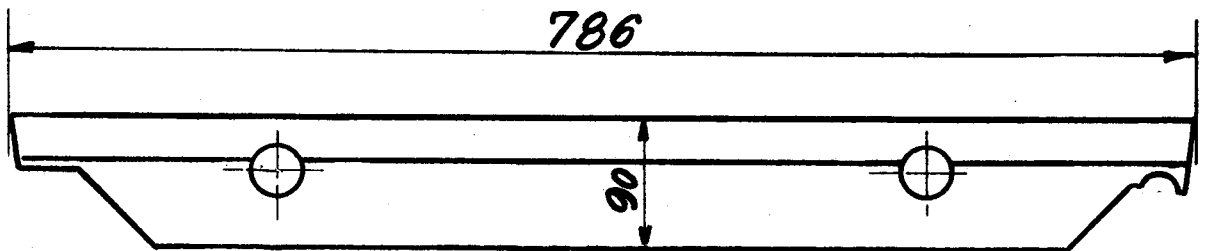
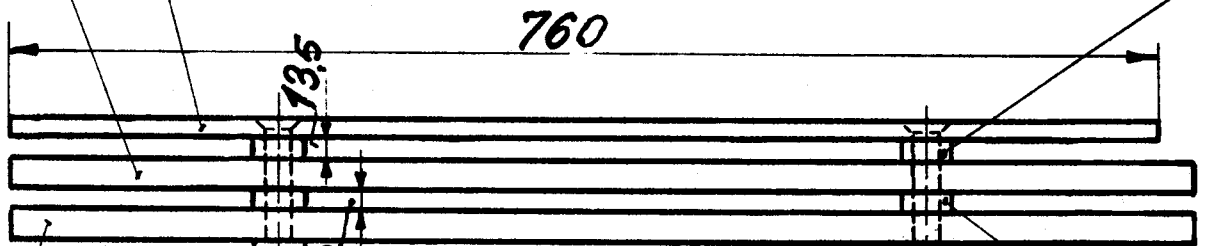
LON. 3.150-3 ;  $L = 786/430$ LON. 3.170-1 ;  $L = 760/430$  højreLON. 3.190-1 ;  $\alpha = 15$ LON. 3.150-9 ;  $L = 786/430$ LON. 3.190-2 ;  $\alpha = 86.5$ LON. 3.190-1 ;  
 $\alpha = 15$ *højre*

Rekvissionsbetegnelse	Materiale	Model Nr.	Minstebeholdn.
Bagsiderist. LON. 3.200-57.	Flussjern.		Kh. Ar.

2

LON.  
D.S.B.

Siderist v. vipperist, ydersæt  
for loko. litra S.

3.200-58

*Kun for svejst fyrkasse*

1949

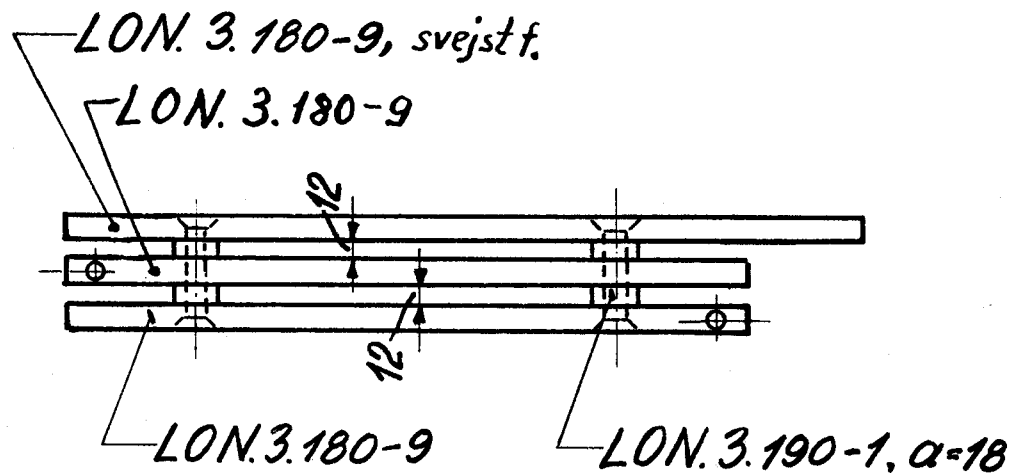
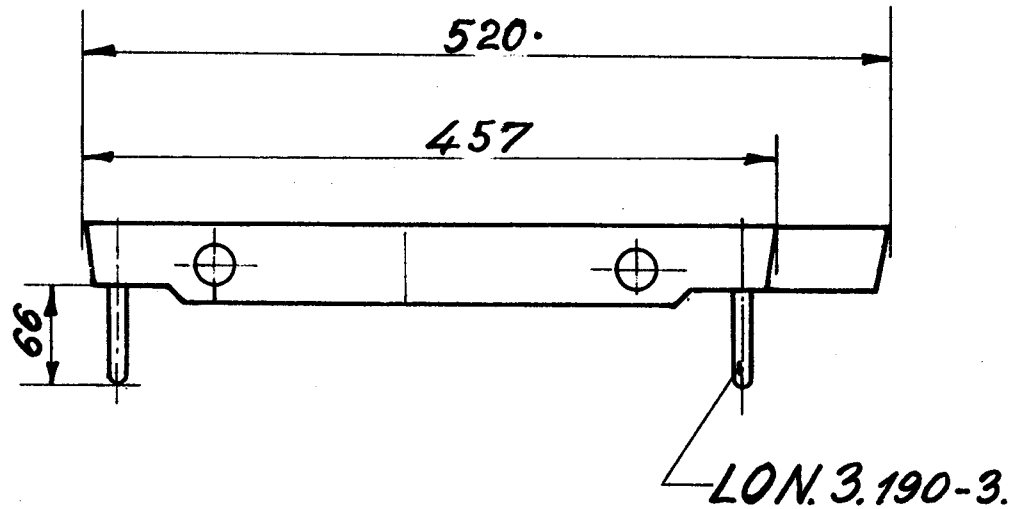

*Venstre siderist som vist.*

*Højre do modsat do.*

Rekvissionsbetegnelse	Materiale	Model nr.	Mindstebeholdn	
Siderist. LON. 3.200-58 <sup>højre</sup> / <sub>venstre</sub>	Flussjern		Kh.	Ar.